



arturo alvarez
emotional light

2014 LISTA DE PRECIOS

ÍNDICE

- 2 **Garantía de autenticidad. Índice de símbolos**
- 3 **Realización de un pedido. Sobre nuestras lámparas. Códigos de color por material**

- 4 **Lámparas de mesa**
- 10 **Lámparas de pie**
- 15 **Lámparas colgantes**
- 32 **Appliques y plafones**

- 42 **Accesorios**
- 43 **Bombillas**
- 44 **Condiciones de venta**

GARANTÍA DE AUTENTICIDAD

Todas las lámparas salen con etiquetas que reflejan la referencia y número de serie. Esta lámpara es un diseño exclusivo y auténtico de la empresa arturo alvarez. Está producida y hecha totalmente a mano en España. Pasa estrictos controles de calidad antes de su salida al mercado.

ÍNDICE DE SÍMBOLOS



Premio otorgado por International Interior Design Association (IIDA) y la revista Hospitality Design



Doble aislamiento y/o aislamiento en cada parte y sin toma de tierra



Luminaria homologada, cumple con la normativa CE



reddot design award

Premio otorgado por Design Zentrum Nordrhein Westfalen



Aparato no adaptado para la instalación en superficies normalmente inflamables



Luminaria diseñada para usar lámparas halógenas de wolframio con pantalla de protección propia



Premio otorgado por Chicago Athenaeum Museo de Arquitectura y Diseño



Con toma de tierra

CÓMO HACER UN PEDIDO

Por favor indique los siguientes datos:

1. Referencia: BE04
2. Color de la tulipa: blanco
3. Color del cable: Transparente
4. Cantidad: 2 unidades

Los pedidos incompletos en los que las referencias sean erróneas, falte el color de la tulipa o el color del cable no serán pasados a producción y el plazo de entrega contará a partir del momento de tener todos los datos correctos.

Los pedidos deberán confirmarse mediante un medio escrito por fax o bien por e-mail:

fax:+34 981 50 20 00

e-mail: pedidos@arturo-alvarez.com

Una vez emita un pedido a fábrica recibirá una CONFIRMACIÓN DE PEDIDO. Cualquier rectificación de pedido deberá hacerla antes de pasadas 48 horas desde que reciba esta confirmación. Si pasadas las 48 horas no recibimos ninguna rectificación, ESE PEDIDO SE DARÁ COMO VÁLIDO EN TODOS SUS TÉRMINOS. Esto significa que, desde ese momento entra en producción y no se puede modificar ni anular.

SOBRE NUESTRAS LÁMPARAS

Todas nuestras lámparas están hechas a mano. Las diferencias entre ellas y en los distintos materiales empleados convierten a cada lámpara en única. Pequeñas diferencias entre lámparas de una misma referencia no son un defecto, sino un valor, cada una es un objeto único. Las dimensiones de las tulipas indicadas son sólo aproximadas y nunca exactas.

CÓDIGOS DE COLOR POR MATERIAL

SIMETECH® by arturo alvarez	CORDÓN	VIDRIO	CELULOSA PRENSADA	TELA	TABLERO MARINO
	42. Blanco	01. Negro		20. Negro	
B. Blanco	43. Gris	02. Blanco	42. Blanco	21. Blanco	WE. Wengué
NA. Naranja	46. Rojo	77. Naranja	43. Gris claro	22. Gris	AM. Amarillo
N. Negro	47. Marrón	83. Azul fuerte	46. Rojo	23. Rojo	B. Blanco
A. Amarillo	48. Amarillo oro	84. Rosa claro	47. Marrón	24. Granate	
G. Gris	49. Marrón medio	85. Verde pistacho	48. Amarillo oro	25. Verde	
	50. Beige	87. Arena	49. Marrón medio		
	51. Verde	89. Ámbar oscuro	50. Beige		
	52. Azul	90. Marrón	51. Verde		
		92. Verde lima	52. Azul		
		95. Beige			
		102. Rojo			

LÁMPARAS DE MESA

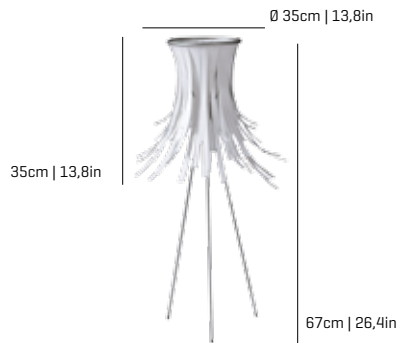

Bety

by Arturo Álvarez

pg. 100 [Catálogo]

ref. BE01

317€

TULIPA

Polipropileno
Un color a elegir

Acero inoxidable





SOPORTE

Acero inoxidable

CABLE

Negro o transparente

230V - 50Hz

-  E14 - Max. 1x9 W
-  E14 - Max. 1x11 W
-  E14 ECO - Max. 1x46 W
-  E14 LED - Max. 1x7 W
-  E14 - Max. 1x60 W

Eficiencia energética: de A+ a E



60x25x20 cm
23,6x9,8x7,9 in
1,5kg | 3,3lb



Certificaciones:

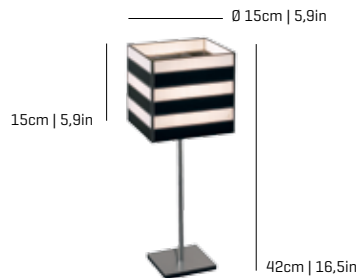

Cebra

by Arturo Álvarez

ref. CE01

284€

TULIPA

Vidrio
Uno o dos colores a elegir





SOPORTE

Acero pintado
y acero inoxidable

CABLE

Negro o transparente

230V - 50Hz

-  E14 - Max. 1x9 W
-  E14 - Max. 1x11 W
-  E14 ECO - Max. 1x46 W
-  E14 LED - Max. 1x7 W
-  E14 - Max. 1x60 W

Eficiencia energética: de A+ a E



35x25x25 cm
13,8x9,8x9,8 in
2,4kg | 5,3lb



Certificaciones:



Curvas

by Arturo Álvarez

ref. CV01

279€

TULIPA

Vidrio
Un color a elegir





SOPORTE

Acero pintado
y acero inoxidable

CABLE

Negro o transparente

230V - 50Hz

-  E14 - Max. 1x9 W
-  E14 ECO - Max. 1x46 W
-  E14 LED - Max. 1x7 W
-  E14 - Max. 1x60 W

Eficiencia energética: de A+ a E



35x25x25 cm
13,8x9,8x9,8 in
2,6kg | 5,7lb



Certificaciones:



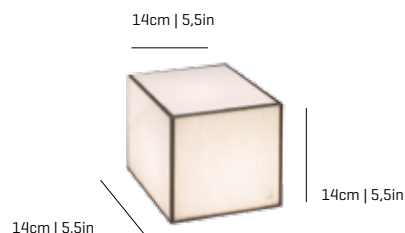

Doscubos

by Arturo Álvarez

ref. D001G

207€

TULIPA

Vidrio
Un color a elegir



SOPORTE

Acero inoxidable

CABLE

Negro o transparente

230V - 50Hz

 G9 LED - Max. 1x3 W
 G9 ECO - Max. 1x42 W
 G9 - Max. 1x60 W

Eficiencia energética: de A+ a C

 20x20x20 cm
 7,9x7,9x7,9 in
 1,7kg | 3,7lb



Certificaciones:

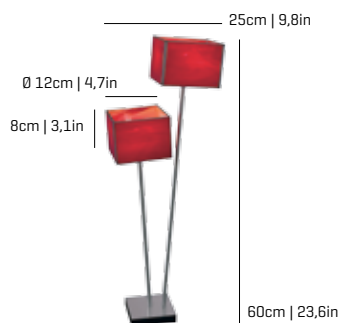

Doscubos

by Arturo Álvarez

ref. D002

394€

TULIPA

Vidrio
Un color a elegir



SOPORTE

Acero pintado
y acero inoxidable

CABLE

Negro o transparente

230V - 50Hz

 G9 LED - Max. 2x3 W
 G9 ECO - Max. 2x42 W
 G9 - Max. 2x40 W

Eficiencia energética: de A+ a C

 60x20x30 cm
 23,6x7,9x11,8 in
 4,1kg | 9lb



Certificaciones:

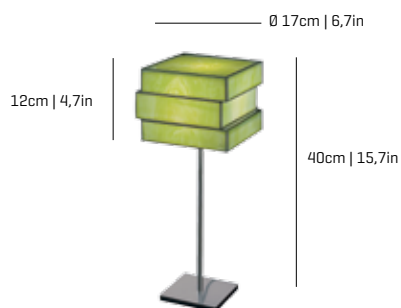

Encaixe

by Arturo Álvarez

ref. EN01

258€

TULIPA

Vidrio
Un color a elegir





SOPORTE

Acero pintado
y acero inoxidable

CABLE

Negro o transparente

230V - 50Hz

 E14 - Max. 1x9 W
 E14 ECO - Max. 1x46 W
 E14 LED - Max. 1x7 W
 E14 - Max. 1x60 W

Eficiencia energética: de A+ a E

 35x25x25 cm
 13,8x9,8x9,8 in
 2,7kg | 6lb



Certificaciones:

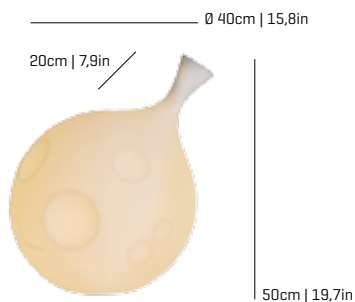

Lua

by Martín Azúa

pg. 172 [Catálogo]

ref. LU01

336€

TULIPA

Poliétileno
Un color



SOPORTE

Acero inoxidable

CABLE

Negro. Largo 4m.

230V - 50Hz [IP55, in8out EU*]

 E27 - Max. 1x23 W
 E27 LED - Max. 1x12 W

*Unión Europea

Eficiencia energética: de A a B

 43x43x62 cm
 16,9x16,9x24,4 in
 4,3kg | 9,4lb



IP55
[in8out EU]

Certificaciones:



arturo alvarez

LÁMPARAS DE MESA

PVP, IVA no incluido. Bombillas no incluidas

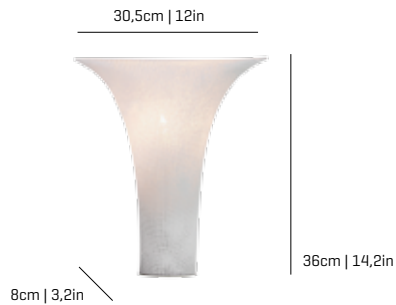
**Muu** by Arturo Álvarez

pg. 88 [Catálogo]

ref. MU01

244€**TULIPA**SIMETECH® by arturo alvarez
pg.180 [Catálogo]

Un color a elegir





SOPORTE

Acero pintado

CABLE

Negro o transparente

230V - 50Hz

-  E14 - Max. 1x9 W
-  E14 - Max. 1x11 W
-  E14 ECO - Max. 1x46 W
-  E14 LED - Max. 1x7 W
-  E14 - Max. 1x60 W

Eficiencia energética: de A+ a E
 42x42x19 cm
16,5x16,5x7,5 in
1,8kg | 3,9lb

Certificaciones:

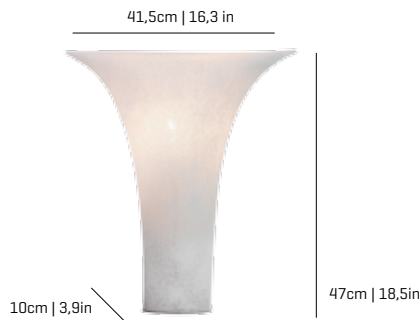
**Muu** by Arturo Álvarez

pg. 88 [Catálogo]

ref. MU02

270€**TULIPA**SIMETECH® by arturo alvarez
pg.180 [Catálogo]

Un color a elegir





SOPORTE

Acero pintado

CABLE

Negro o transparente

230V - 50Hz

-  E14 - Max. 1x9 W
-  E14 - Max. 1x11 W
-  E14 ECO - Max. 1x46 W
-  E14 LED - Max. 1x7 W
-  E14 - Max. 1x60 W

Eficiencia energética: de A+ a E
 52x46x21 cm
20,5x18,1x8,3 in
2,4kg | 5,4lb

Certificaciones:

**Nevo** by Arturo Álvarez

pg. 66 [Catálogo]

ref. NE01





345€**TULIPA**SIMETECH® by arturo alvarez
pg.180 [Catálogo]

Un color a elegir

Acero niquel-satinado
y acero inoxidable**SOPORTE**Acero pintado
y acero inoxidable**CABLE**

Negro o transparente

230V - 50Hz

-  E14 - Max. 2x9 W
-  E14 - Max. 2x11 W
-  E14 ECO - Max. 2x46 W
-  E14 LED - Max. 2x7 W
-  E14 - Max. 2x60 W

Eficiencia energética: de A+ a E
 42x42x19 cm
16,5x16,5x7,5 in
2,5kg | 5,5lb

Certificaciones:

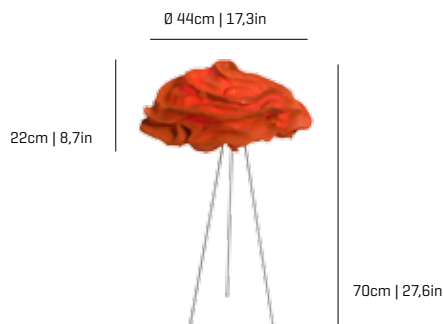
**Nevo** by Arturo Álvarez

pg. 66 [Catálogo]

ref. NE02

441€**TULIPA**SIMETECH® by arturo alvarez
pg.180 [Catálogo]

Un color a elegir





Acero niquel-satinado
y acero inoxidable**SOPORTE**

Acero inoxidable

CABLE

Negro o transparente

230V - 50Hz

-  E14 - Max. 2x9 W
-  E14 - Max. 2x11 W
-  E14 ECO - Max. 2x46 W
-  E14 LED - Max. 2x7 W
-  E14 - Max. 2x60 W

Eficiencia energética: de A+ a E
 60x60x20 cm
23,6x23,6x7,9 in
4kg | 8,8lb

Certificaciones:





Norman

by Arturo Álvarez

ref. **N001****343€****TULIPA**

Vidrio
Un color a elegir

SOPORTE

Acero inoxidable

CABLE

Negro o transparente

230V - 50Hz

G24d2 - Max. 1x18 W

Eficiencia energética: de A a B
 35x25x25 cm
13,8x9,8x9,8 in
3,3kg | 7,3lb

Certificaciones:



Senda

by Arturo Álvarez

ref. **SN01****268€****TULIPA**

Vidrio
Un color a elegir

SOPORTEAcero pintado
y acero inoxidable**CABLE**

Negro o transparente

230V - 50Hz

E14 - Max. 1x9 W

E14 - Max. 1x11 W

E14 ECO - Max. 1x46 W

E14 LED - Max. 1x7 W

E14 - Max. 1x60 W

Eficiencia energética: de A+ a E
 35x25x25 cm
13,8x9,8x9,8 in
2,3kg | 5,1lb

Certificaciones:



Shio

by Arturo Álvarez

pg. 144

ref. **SH02: 444€**ref. **SH02-D*: 489€****TULIPA**

Tablero marino
Un color a elegir

Acero pintado

CABLE

Negro o transparente

Difusor superior e inferior

*Regulable

230V - 50Hz

2GX13 - Max. 1x22 W

Eficiencia energética: de A a B
 43x43x50 cm
16,9x16,9x19,7 in
5kg | 11lb

Certificaciones:



Sophi

by Arturo Álvarez

ref. **SP01****331€****TULIPA**

Vidrio
Un color a elegir o
combinaciones:
Marrón
Ámbar
B6N+otro

SOPORTEAcero pintado
y acero inoxidable**CABLE**

Negro o transparente

230V - 50Hz

E14 - Max. 1x9 W

E14 - Max. 1x7 W

E14 ECO - Max. 1x46 W

E14 LED - Max. 1x7 W

E14 - Max. 1x60 W

Eficiencia energética: de A+ a E
 50x20x25 cm
19,7x7,9x9,8 in
2,6kg | 5,7lb

Certificaciones:



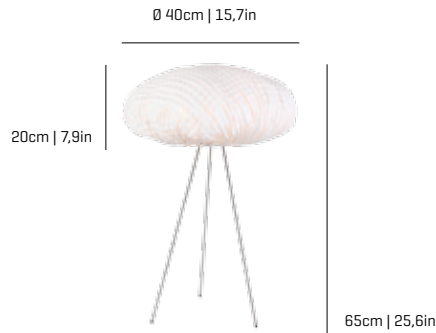

arturo alvarez

LÁMPARAS DE MESA

PVP, IVA no incluido. Bombillas no incluidas

Tati

by Arturo Álvarez

pg. 52 [Catálogo]

ref. TA02

412€

TULIPA

SIMETECH® by arturo alvarez
pg.180 [Cataloghe]

Un color a elegir

Acero niquel-satinado
y acero inoxidable





SOPORTE

Acero inoxidable

CABLE

Negro o transparente

230V - 50Hz

-  E14 - Max. 2x9 W
-  E14 - Max. 2x11 W
-  E14 ECO - Max. 2x46 W
-  E14 LED - Max. 2x7 W
-  E14 - Max. 2x60 W

Eficiencia energética: de A+ a E

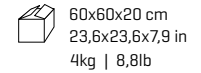

Certificaciones:



Vento

by Arturo Álvarez pg. 116 [Catálogo]

ref. VN01

684€

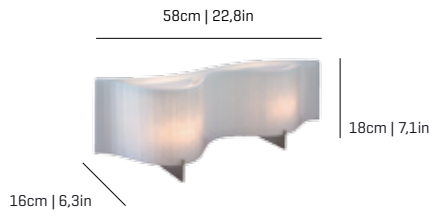

TULIPA

Vidrio

Un color a elegir
o combinaciones:Rosa
Marrón
B&N

SOPORTE



Acero inoxidable

CABLE

Negro o transparente

Incluye difusor

230V - 50Hz

-  G9 LED - Max. 2x3 W
-  G9 ECO - Max. 2x42 W [Philips]
-  G9 ECO - Max. 2x33 W [Osram]

Eficiencia energética: de A+ a C

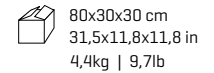

Certificaciones:



AVISO IMPORTANTE: Las colecciones VENTO y VENTOPOP sólo son aptas para uso con bajo consumo G9 o halógenas G9 ECO

Vento

by Arturo Álvarez pg. 116 [Catálogo]

ref. VN02: 921€

ref. VN02-L*: 1086€

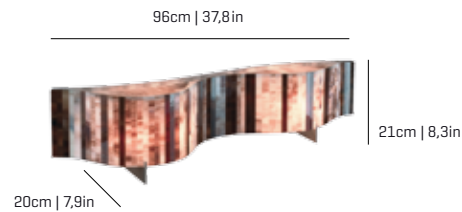

TULIPA

Vidrio

Un color a elegir
o combinaciones:Rosa
Marrón
B&N

SOPORTE



Acero inoxidable

CABLE

Negro o transparente

Incluye difusor

230V - 50Hz

-  G9 LED - Max. 4x3 W
-  G9 ECO - Max. 4x42 W [Philips]
-  G9 ECO - Max. 4x33 W [Osram]

*LED - 1x21,6 W - 1735Lm - 3.000K

Eficiencia energética: de A+ a C

*Eficiencia energética: de A++ a A

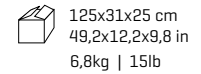

Certificaciones:



AVISO IMPORTANTE: Las colecciones VENTO y VENTOPOP sólo son aptas para uso con bajo consumo G9 o halógenas G9 ECO

Ventopop

by Arturo Álvarez pg. 123 [Catálogo]

ref. VN01POP

707€



TULIPA

Vidrio

Colores combinación POP

SOPORTE



Acero inoxidable

CABLE

Negro o transparente

Incluye difusor

230V - 50Hz

-  G9 LED - Max. 2x3 W
-  G9 ECO - Max. 2x42 W [Philips]
-  G9 ECO - Max. 2x33 W [Osram]

Eficiencia energética: de A+ a C

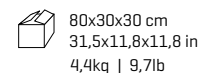

Certificaciones:



AVISO IMPORTANTE: Las colecciones VENTO y VENTOPOP sólo son aptas para uso con bajo consumo G9 o halógenas G9 ECO

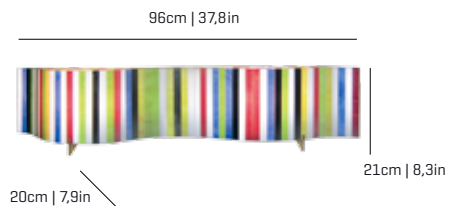

Ventopop

by Arturo Álvarez

ref. VN02POP: **981€** ref. VN02POP-L*: **1159€**

TULIPA

Vidrio

Colores combinación POP

pg. 121 [Catálogo]

SOPORTE

Acero inoxidable

CABLE

Negro o transparente

Incluye difusor

230V - 50Hz

G9 LED - Max. 4x3 W

G9 ECO - Max. 4x42 W (Philips)

G9 ECO - Max. 4x33 W (Osram)

*LED - 1x21,6 W - 1735Lm - 3.000K

Eficiencia energética: de A+ a C

*Eficiencia energética: de A++ a A

 125x31x25 cm
49,2x12,2x9,8 in
6,8kg | 15lb

Certificaciones:



AVISO IMPORTANTE: Las colecciones VENTO y VENTOPOP sólo son aptas para uso con bajo consumo G9 o halógenas G9 ECO

Ø 130cm | 51,2in



LÁMPARAS DE PIE

Ø 60cm | 23,6in

220cm | 86,6in

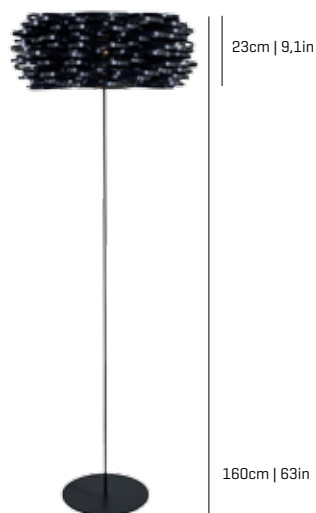

23cm | 9,1in

160cm | 63in

Ø 60cm | 23,6in

23cm | 9,1in

188cm | 74in

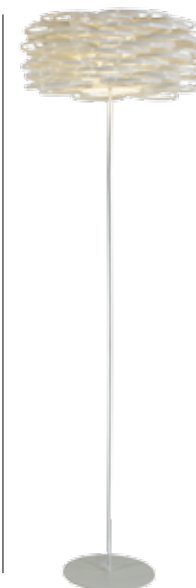

Africa by arturo alvarez team ref. AF03 7950€

TULIPA

SIMETECH® by arturo alvarez
pg.180 [Catálogo]

Un color a elegir

241x133x133 cm
94,9x52,4x52,4 in
103kg | 277lb

SOPORTE

Acero inoxidable pintado
y acero pintado

CABLE

Negro o transparente

Certificaciones:



pg. 84 [Catálogo]

**Transporte no incluido,
consultar precio.**

230V - 50Hz

- E27 - Max. 3x23 W
- E27 - Max. 3x23 W
- E27 LED - Max. 3x11 W
- E27 ECO - Max. 3x77 W
- E27 LED - Max. 3x12 W
- E27 - Max. 3x100 W

Eficiencia energética: de A+ a E

Aros by Arturo Álvarez ref. AR03 448€

TULIPA

Polipropileno
Un color a elegir

Acero pintado

SOPORTE

Acero inoxidable pintado
y acero pintado

CABLE

Negro o transparente

4kg | 8,8lb
170x10x10 cm
66,9x3,9x3,9 in
61x61x32 cm
24x24x12,6 in

Certificaciones:



pg. 113 [Catálogo]

230V - 50Hz

- E27 - Max. 1x23 W
- E27 - Max. 1x23 W
- E27 LED - Max. 1x11 W
- E27 ECO - Max. 1x77 W
- E27 LED - Max. 1x12 W
- E27 - Max. 1x100 W

Eficiencia energética: de A+ a E

Aros by Arturo Álvarez ref. AR03G 517€

TULIPA

Polipropileno
Un color a elegir

Acero pintado

SOPORTE

Acero inoxidable pintado
y acero pintado

CABLE

Negro o transparente

4kg | 8,8lb
180x10x10 cm
70,9x3,9x3,9 in
61x61x32 cm
24x24x12,6 in

Certificaciones:



pg. 113 [Catálogo]

230V - 50Hz

- E27 - Max. 1x23 W
- E27 - Max. 1x23 W
- E27 LED - Max. 1x11 W
- E27 ECO - Max. 1x77 W
- E27 LED - Max. 1x12 W
- E27 - Max. 1x100 W

Eficiencia energética: de A+ a E

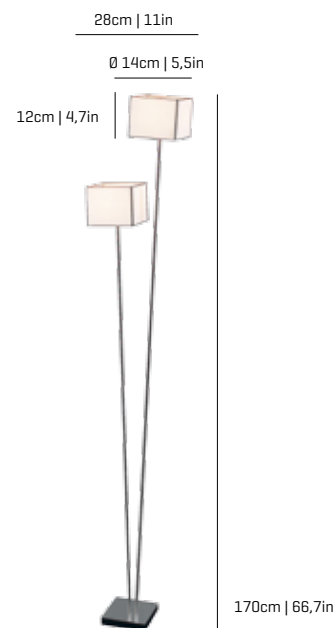
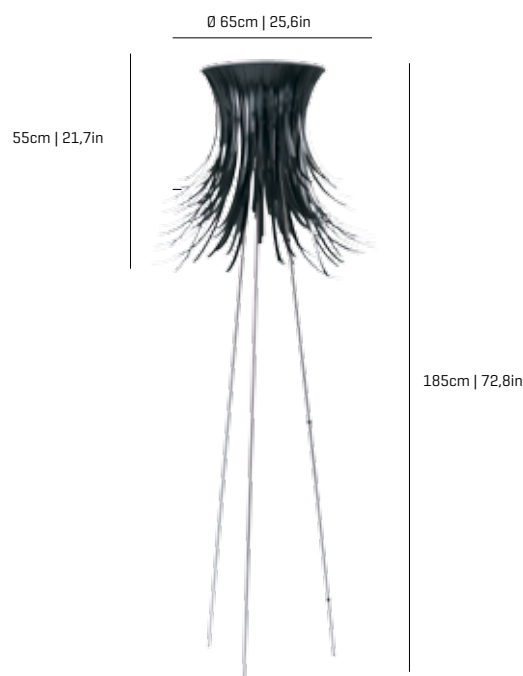
**Bety** by Arturo Álvarez

ref. BE03

622€**TULIPA**

Polipropileno
Un color a elegir



6,5kg | 14,3lb

180x10x10 cm
70,9x3,9x3,9 in

SOPORTE

Acero inoxidable

43x43x60 cm
16,9x16,9x23,6 in

CABLE

Negro o transparente



Certificaciones:



230V - 50Hz

- E27 - Max. 1x23 W
- E27 - Max. 1x23 W
- E27 LED - Max. 1x11 W
- E27 ECO - Max. 1x77 W
- E27 LED - Max. 1x12 W
- E27 - Max. 1x100 W

pg. 101 [Catálogo]

Eficiencia energética: de A+ a E

Curvas by Arturo Álvarez

ref. CV03G

1127€**TULIPA**

Vidrio
Un color a elegir



15kg | 33,1lb

185x45x25 cm
72,8x17,7x9,8 in

SOPORTE

Acero pintado y acero inoxidable

60x60x30 cm
23,6x23,6x11,8 in

CABLE

Negro o transparente



Certificaciones:



Difusor superior e inferior

Regulable

230V - 50Hz

- E27 - Max. 4x23 W
- E27 Dimmer - Max. 4x20 W
- E27 ECO - Max. 4x77 W
- E27 LED - Max. 4x12 W
- E27 - Max. 4x100 W

Eficiencia energética: de A+ a E

Doscubos by Arturo Álvarez

ref. D003

552€**TULIPA**

Vidrio
Un color a elegir



17kg | 37,5lb

170x20x20 cm
66,9x7,9x7,9 in

SOPORTE

Acero pintado y acero inoxidable

35x25x25 cm
13,8x9,8x9,8 in

CABLE

Negro o transparente



Certificaciones:



230V - 50Hz

- E14 - Max. 2x9 W
- E14 ECO - Max. 2x46 W
- E14 LED - Max. 2x7 W
- E14 - Max. 2x60 W

Eficiencia energética: de A+ a E

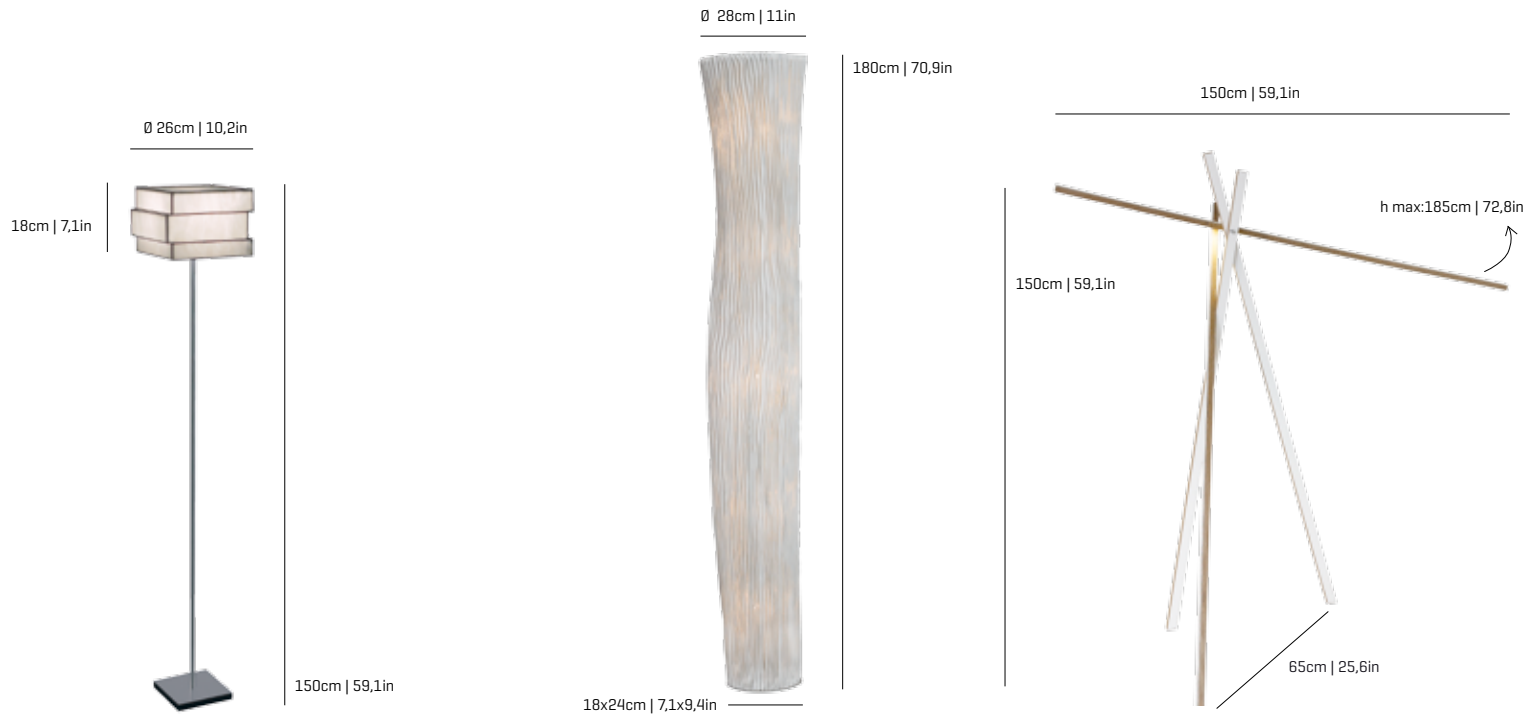

Encaixe by Arturo Álvarez ref. EN03 511€

TULIPA

Vidrio

Un color a elegir

11kg | 24,3lb

145x20x20 cm
57,1x7,9x7,9 in

42x42x30 cm
16,5x16,5x11,8 in

SOPORTE

Acero pintado y acero inoxidable



Certificaciones:



CABLE

Negro o transparente

230V - 50Hz

- E27 - Max. 1x23 W
- E27 ECO - Max. 1x77 W
- E27 LED - Max. 1x12 W
- E27 - Max. 1x100 W

Eficiencia energética: de A+ a E

Gea by Arturo Álvarez ref. GE03 1621€

TULIPA

SIMETECH® by arturo alvarez
pg.180 [Catálogo]

Un color a elegir

19kg | 41,9lb

188x43x26 cm
74x16,9x10,2 in

SOPORTE

Acero pintado y acero inoxidable



Certificaciones:



CABLE

Negro o transparente

Regulable



230V - 50Hz

- E27 - Max. 5x23 W
- E27 Dimmer- Max. 5x20 W
- E27 ECO - Max. 5x77 W
- E27 LED - Max. 5x12 W
- E27 - Max. 5x100 W

Eficiencia energética: de A+ a E

Le by Arturo Álvarez ref. LE03 607€

TULIPA

Tablero marino

Un color a elegir

6,4kg | 14,1lb

169x21x21 cm
66,5x8,3x8,3 in

CABLE

Transparente



Certificaciones:



230V - 50Hz

LED - 1x18 W - 1446Lm - 3000K

Eficiencia energética: de A++ a A

pg. 150 [Catálogo]

pg. 38 [Catálogo]

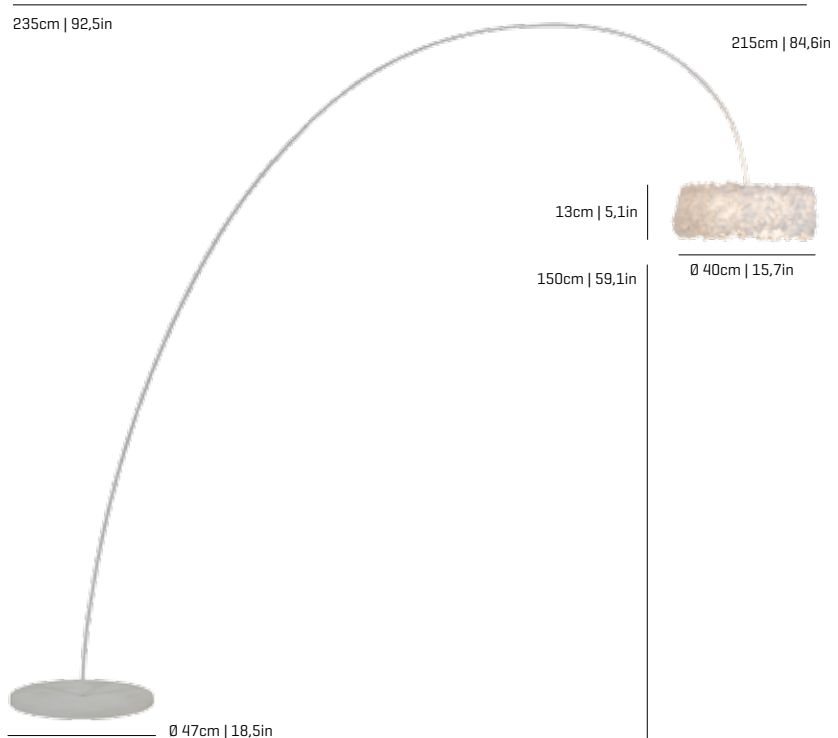

Miuu

by Arturo Álvarez

ref. MI03

1171€

TULIPA

Tela

Un color a elegir
o combinación de dos colores

Acero pintado

41,4kg | 91,3lb

192x63x23 cm
75,6x24,8x9,1 in
60x51x16 cm
23,6x20,1x6,3 in

SOPORTE

Acero inoxidable pintado
y acero pintado

SOPORTE blanco:
con tulipas en color blanco o gris
o con combinación de:
blanco+otro color

SOPORTE negro:
con tulipas en color negro, rojo, granate
o verde, o con combinaciones de:
negro+otro color



Certificaciones:



230V - 50Hz

2GX13 - Max. 1x22 W

Eficiencia energética: de A a B

CABLE

Negro o transparente

pg. 160 [Catálogo]

Difusor superior e inferior

Shio

by Arturo Álvarez

ref. SH03:

905€

ref. SH03-D*:

952€

TULIPA

Tablero marino

Un color a elegir

Acero pintado

Difusor superior e inferior

CABLE

Negro o transparente

*Regulable

11,9kg | 26,2lb

156x10x10 cm
61,4x3,9x3,9 in
61x61x21 cm
24x24x8,3 in



Certificaciones:



230V - 50Hz

2GX13 - Max. 1x55 W

Eficiencia energética: de A a B

pg. 145 [Catálogo]

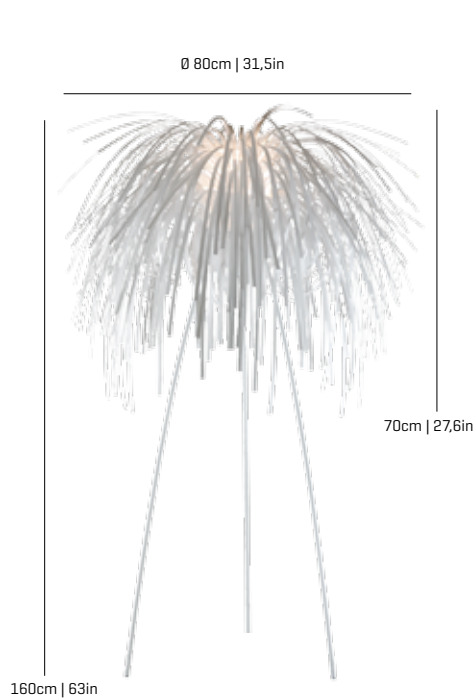

Tina

by Arturo Álvarez

ref. TN03

667€

TULIPA

Polipropileno
Un color a elegir

 6,5kg | 14,3lb
125x31x25 cm
49,2x12,2x9,8in

Acero pintado

SOPORTE

Acero inoxidable pintado
y acero pintado









Certificaciones:



CABLE

Negro o transparente

230V - 50Hz

-  E27 - Max. 1x23 W
-  E27 - Max. 1x23 W
-  E27 LED - Max. 1x11 W
-  E27 ECO - Max. 1x116 W
-  E27 LED - Max. 1x12 W
-  E27 - Max. 1x100 W

pg. 104 [Catálogo]

Eficiencia energética: de A+ a E

V

by Héctor Serrano

ref. VV03

1377€

TULIPA

Policarbonato
Un color a elegir

 17kg | 37,5lb
150x50x12 cm
59,1x19,7x4,7 in
83x83x37 cm
32,7x32,7x14,6 in

Difusor de vidrio

SOPORTE

Acero pintado







CABLE

Negro o transparente

Certificaciones:



230V - 50Hz

-  E27 - Max. 1x23 W
-  E27 ECO - Max. 1x77 W
-  E27 LED - Max. 1x12 W
-  E27 - Max. 1x100 W

pg. 167 [Catálogo]

Eficiencia energética: de A+ a E

LÁMPARAS COLGANTES

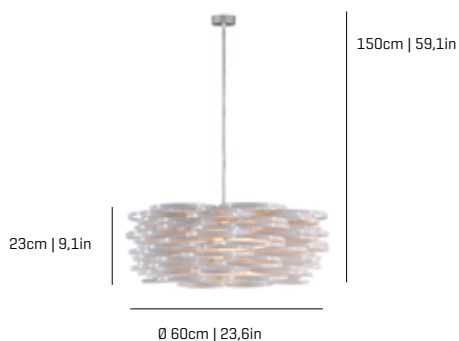

Aros

by Arturo Álvarez

pg. 112 [Catálogo]

ref. AR04

367€

TULIPA

Polipropileno
Un color a elegir

Acero pintado

FLORÓN

Acero níquel-satinado

CABLE

Negro o transparente

230V - 50Hz



E27 - Max. 1x23 W



E27 - Max. 1x23 W



E27 LED - Max. 1x11 W



E27 ECO - Max. 1x77 W



E27 LED - Max. 1x12 W



E27 - Max. 1x100 W

Eficiencia energética: de A+ a E



61x61x32 cm
24x24x12,6 in
2,8kg | 6,2lb



Certificaciones:

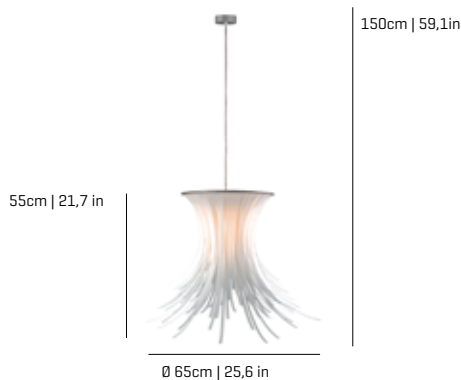

Bety

by Arturo Álvarez

pg. 98 [Catálogo]

ref. BE04

388€

TULIPA

Polipropileno
Un color a elegir

Acero inoxidable

FLORÓN

Acero níquel-satinado

CABLE

Negro o transparente

230V - 50Hz



E27 - Max. 1x23 W



E27 - Max. 1x23 W



E27 LED - Max. 1x11 W



E27 ECO - Max. 1x77 W



E27 LED - Max. 1x12 W



E27 - Max. 1x100 W

Eficiencia energética: de A+ a E



43x43x62 cm
16,9x16,9x24,4 in
2,2kg | 4,9lb



Certificaciones:



Bety

by Arturo Álvarez

pg. 99 [Catálogo]

ref. BE04-1

316€

TULIPA

Polipropileno
Un color a elegir

Acero inoxidable

FLORÓN

Acero níquel-satinado

CABLE

Negro o transparente

230V - 50Hz



E14 - Max. 1x9 W



E14 - Max. 1x11 W



E14 ECO - Max. 1x46 W



E14 LED - Max. 1x7 W



E14 - Max. 1x60 W

Eficiencia energética: de A+ a E



50x20x25 cm
19,7x7,9x9,8 in
1,2kg | 2,6lb



Certificaciones:



arturo alvarez

LÁMPARAS COLGANTES

PVP, IVA no incluido. Bombillas no incluidas



Caos

 by Arturo Álvarez ref. CA04A: **299€** ref. CA04A-L*: **449€** ref. CA04A-LD***: **503€**
TULIPA

Cordón
Un color a elegir

Acero inoxidable

pg. 9 [Catálogo]

FLORÓN

Acero níquel-satinado

CABLE

Negro o transparente

**Regulable

230V - 50Hz

E27 - Max. 1x23 W

E27 LED - Max. 1x11 W

E27 ECO - Max. 1x77 W

E27 LED - Max. 1x12 W

*LED - 1x15,30 W - 1750Lm - 3000K

 40x40x40 cm
15,7x15,7x15,7 in
1,5kg | 3,3lb

Eficiencia energética: de A+ a E

*Eficiencia energética: de A++ a A

Certificaciones:



Caos

 by Arturo Álvarez pg. 8 [Catálogo] ref. CA04AG: **409€** ref. CA04AG-LD*: **799€**
TULIPA

Cordón
Un color a elegir

Acero inoxidable

FLORÓN

Acero níquel-satinado

CABLE

Negro o transparente

*Regulable

230V - 50Hz

E27 - Max. 1x23 W

E27 LED - Max. 1x11 W

E27 ECO - Max. 1x77 W

E27 LED - Max. 1x12 W

*LED - 1x34,10 W - 3550Lm - 3000K

 50x50x50 cm
19,7x19,7x19,7 in
3kg | 6,6lb

Eficiencia energética: de A+ a E

*Eficiencia energética: de A++ a A

Certificaciones:



Caos

 by Arturo Álvarez ref. CA04B: **296€** ref. CA04B-L*: **445€** ref. CA04B-LD***: **495€**
TULIPA

Cordón
Un color a elegir

Acero inoxidable

pg. 10 [Catálogo]

FLORÓN

Acero níquel-satinado

CABLE

Negro o transparente

**Regulable

230V - 50Hz

E27 - Max. 1x23 W

E27 LED - Max. 1x11 W

E27 ECO - Max. 1x77 W

E27 LED - Max. 1x12 W

*LED - 1x15,30 W - 1750Lm - 3000K

 36x36x30 cm
14,2x14,2x11,8 in
1,5kg | 3,3lb

Eficiencia energética: de A+ a E

*Eficiencia energética: de A++ a A

Certificaciones:



Caos

 by Arturo Álvarez pg. 13 [Catálogo] ref. CA04A-3 **1575€**
TULIPA

Cordón
Un color a elegir

Acero inoxidable

refs. 3xCA04A

FLORÓN

DIBOND®

CABLE

Transparente

230V - 50Hz

E27 - Max. 3x23 W

E27 LED - Max. 3x11 W

E27 ECO - Max. 3x77 W

E27 LED - Max. 3x12 W

 60x80x92 cm
23,6x31,5x36,2 in
8kg | 17,6lb

Eficiencia energética: de A+ a E

Certificaciones:



arturo alvarez

LÁMPARAS COLGANTES

PVP, IVA no incluido. Bombillas no incluidas



Caos

 by Arturo Álvarez pg. 14 [Catálogo]

ref. CA04A-4

2695€

TULIPACordón
Un color a elegir

Acero inoxidable

refs. 3xCA04A, 1xCA04AG

FLORÓN

DIBOND®

CABLE

Transparente

230V - 50Hz

E27 - Max. 4x23 W

E27 LED - Max. 4x11 W

E27 ECO - Max. 4x77 W

E27 LED - Max. 4x12 W

 80x120x115 cm
31,5x47,2x45,3 in
18kg | 39,6lb

Eficiencia energética: de A+ a E

Certificaciones:



Caos

 by Arturo Álvarez pg. 12 [Catálogo]

ref. CA04A-6

3435€

TULIPACordón
Un color a elegir o combinación de dos o tres colores
Acero inoxidable

refs. 6xCA04A

FLORÓN

DIBOND®

CABLE

Transparente

230V - 50Hz

E27 - Max. 6x23 W

E27 LED - Max. 6x11 W

E27 ECO - Max. 6x77 W

E27 LED - Max. 6x12 W

 80x120x115 cm
31,5x47,2x45,3 in
20kg | 44lb

Eficiencia energética: de A+ a E

Certificaciones:



Caos

 by Arturo Álvarez pg. 11 [Catálogo]

ref. CA04AB-3

1575€

TULIPACordón
Un color a elegir o combinación de dos o tres colores
Acero inoxidable

refs. 1xCA04A, 2xCA04B

FLORÓN

DIBOND®

CABLE

Transparente

230V - 50Hz

E27 - Max. 3x23 W

E27 LED - Max. 3x11 W

E27 ECO - Max. 3x77 W

E27 LED - Max. 3x12 W

 60x80x92 cm
23,6x31,5x36,2 in
7,7kg | 17lb

Eficiencia energética: de A+ a E

Certificaciones:



Coral Cay

 by Arturo Álvarez pg. 28 [Catálogo]

ref. COCY04

324€

TULIPASIMETECH® by arturo alvarez
pg.180 [Catálogo]

Un color a elegir

Acero inoxidable

FLORÓN

Acero níquel-satinado

CABLE

Negro o transparente

230V - 50Hz

E27 - Max. 1x23 W

E27 - Max. 1x23 W

E27 LED - Max. 1x11 W

E27 ECO - Max. 1x77 W

E27 LED - Max. 1x12 W

E27 - Max. 1x100 W

 36x36x30 cm
14,2x14,2x11,8 in
1,6kg | 3,4lb

Eficiencia energética: de A+ a E

Certificaciones:





Coral Galaxea

by Arturo Álvarez pg. 29 [Catálogo] ref. COGA04

324€

TULIPA

SIMETECH® by arturo alvarez
pg.180 [Catálogo]

Un color a elegir

Acero inoxidable

FLORÓN

Acero níquel-satinado

CABLE

Negro o transparente

230V - 50Hz

E27 - Max. 1x23 W

E27 - Max. 1x23 W

E27 LED - Max. 1x11 W

E27 ECO - Max. 1x77 W

E27 LED - Max. 1x12 W

E27 - Max. 1x100 W

36x36x30 cm
14,2x14,2x11,8 in
1,6kg | 3,4lb



Certificaciones:



Eficiencia energética: de A+ a E



Coral Reef

by Arturo Álvarez pg. 29 [Catálogo] ref. CORE04

326€

TULIPA

SIMETECH® by arturo alvarez
pg.180 [Catálogo]

Un color a elegir

Acero inoxidable

FLORÓN

Acero níquel-satinado

CABLE

Negro o transparente

230V - 50Hz

E27 - Max. 1x23 W

E27 - Max. 1x23 W

E27 LED - Max. 1x11 W

E27 ECO - Max. 1x77 W

E27 LED - Max. 1x12 W

E27 - Max. 1x100 W

61x27x20 cm
24x10,6x7,9 in
1,8kg | 4lb



Certificaciones:



Eficiencia energética: de A+ a E



Coral Sea

by Arturo Álvarez pg. 28 [Catálogo] ref. COSE04

324€

TULIPA

SIMETECH® by arturo alvarez
pg.180 [Catálogo]

Un color a elegir

Acero inoxidable

FLORÓN

Acero níquel-satinado

CABLE

Negro o transparente

230V - 50Hz

E27 - Max. 1x23 W

E27 - Max. 1x23 W

E27 LED - Max. 1x11 W

E27 ECO - Max. 1x77 W

E27 LED - Max. 1x12 W

E27 - Max. 1x100 W

36x36x30 cm
14,2x14,2x11,8 in
1,7kg | 3,7lb



Certificaciones:



Eficiencia energética: de A+ a E



Coral Seaurchin

by Arturo Álvarez pg. 27 [Catálogo] ref. COAU04

350€

TULIPA

SIMETECH® by arturo alvarez
pg.180 [Catálogo]

Un color a elegir

Acero inoxidable

FLORÓN

Acero níquel-satinado

CABLE

Negro o transparente

230V - 50Hz

E27 - Max. 1x23 W

E27 - Max. 1x23 W

E27 LED - Max. 1x11 W

E27 ECO - Max. 1x77 W

E27 LED - Max. 1x12 W

E27 - Max. 1x100 W

44x43x31 cm
17,3x16,9x12,2 in
2,4kg | 5,4lb



Certificaciones:



Eficiencia energética: de A+ a E

arturo alvarez

LÁMPARAS COLGANTES

PVP, IVA no incluido. Bombillas no incluidas



Coral Seaurchin

by Arturo Álvarez

pg. 26 [Catálogo]

ref. COAU04G

698€

TULIPA

SIMETECH® by arturo alvarez
pg.180 [Catálogo]

Un color a elegir

Acero inoxidable

FLORÓN

Acero niquel-satinado

CABLE

Negro o transparente

230V - 50Hz

E27 - Max. 4x23 W

E27 - Max. 4x23 W

E27 LED - Max. 4x11 W

E27 ECO - Max. 4x77 W

E27 LED - Max. 4x12 W

E27 - Max. 4x100 W

71x71x42 cm
28x28x16,5 in
6,4kg | 14,1lb

Certificaciones:



Eficiencia energética: de A+ a E

60x60cm | 23,6x 23,6in

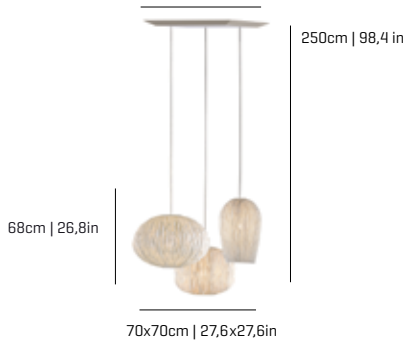

Coral

by Arturo Álvarez

pg. 32 [Catálogo]

ref. C004-3

1299€

TULIPA

SIMETECH® by arturo alvarez
pg.180 [Catálogo]

Un color a elegir

Acero inoxidable

FLORÓN

DIBOND®

CABLE

Transparente

230V - 50Hz

E27 - Max. 3x23 W

E27 ECO - Max. 3x77 W

E27 LED - Max. 3x12 W

E27 - Max. 3x100 W

60x80x85 cm
23,6x31,5x33,5 in
11kg | 24,3lb

Certificaciones:



Eficiencia energética: de A+ a E

refs. 1xCOAU04, 1xCOSE04, 1xCOGA04

60x60cm | 23,6x 23,6in



Coral

by Arturo Álvarez

pg. 33 [Catálogo]

ref. C004-5

2021€

TULIPA

SIMETECH® by arturo alvarez
pg.180 [Catálogo]

Un color a elegir

Acero inoxidable

FLORÓN

DIBOND®

CABLE

Transparente

230V - 50Hz

E27 - Max. 5x23 W

E27 ECO - Max. 5x77 W

E27 LED - Max. 5x12 W

E27 - Max. 5x100 W

60x80x110 cm
31,5x31,5x43,3 in
12kg | 26,5lb

Certificaciones:



Eficiencia energética: de A+ a E

refs. 1xCOAU04, 1xCOCY04, 1xCOSE04,
1xCOGA04, 1xCORE04

120x120 cm | 47,2x47,2in

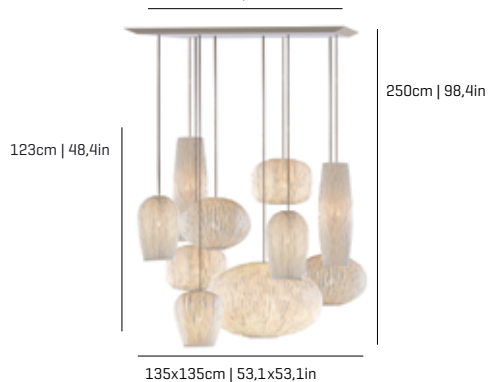

Coral

by Arturo Álvarez

pg. 34 [Catálogo]

ref. C004-10

4411€

TULIPA

SIMETECH® by arturo alvarez
pg.180 [Catálogo]

Un color a elegir

Acero inoxidable

FLORÓN

DIBOND®

CABLE

Transparente

230V - 50Hz

E27 - Max. 13x23 W

E27 ECO - Max. 13x77 W

E27 LED - Max. 13x12 W

E27 - Max. 13x100 W

80x120x145 cm
31,5x47,2x57,1 in
35,2kg | 77,6lb

Certificaciones:



Eficiencia energética: de A+ a E

refs. 2xCOAU04, 1xCOCY04, 2xCOSE04,
2xCOGA04, 2xCORE04, 1xCOAU04G

arturo alvarez

LÁMPARAS COLGANTES

PVP, IVA no incluido. Bombillas no incluidas



Curvas

by Arturo Álvarez pg. 126 [Catálogo]

ref. CV04

576€

TULIPA

Vidrio
Un color a elegir

FLORÓN

Acero níquel-satinado

CABLE

Negro o transparente

230V - 50Hz

E27 - Max. 1x23 W

E27 - Max. 1x23 W

E27 LED - Max. 1x11 W

E27 ECO - Max. 1x77 W

E27 LED - Max. 1x12 W

E27 - Max. 1x100 W

 42x42x30 cm
16,5x16,5x11,8 in
4,4kg | 9,7lb

Certificaciones:



Eficiencia energética: de A+ a E

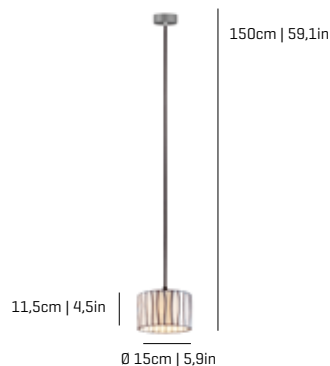

Curvas

by Arturo Álvarez pg. 126 [Catálogo]

ref. CV04-1

241€

TULIPA

Vidrio
Un color a elegir

FLORÓN

Acero níquel-satinado

CABLE

Negro o transparente

230V - 50Hz

E14 - Max. 1x9 W

E14 ECO - Max. 1x46 W

E14 LED - Max. 1x7 W

E14 - Max. 1x60 W

 20x20x20 cm
7,9x7,9x7,9 in
1,7kg | 3,7lb

Certificaciones:



Eficiencia energética: de A+ a E

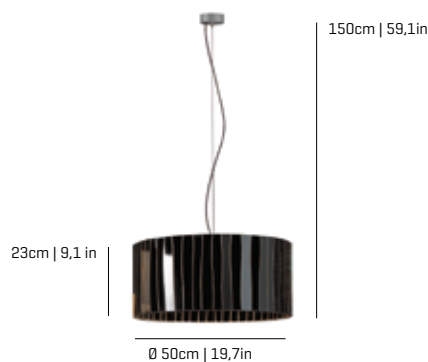

Curvas

by Arturo Álvarez pg. 126 [Catálogo]

ref. CV04G

988€

TULIPA

Vidrio
Un color a elegir

FLORÓN

Acero níquel-satinado

CABLE

Negro o transparente

Difusor superior e inferior

230V - 50Hz

E27 - Max. 4x23 W

E27 ECO - Max. 4x77 W

E27 LED - Max. 4x12 W

E27 - Max. 4x100 W

 62x62x32 cm
24,4x24,4x12,6 in
8,7kg | 19,1lb

Certificaciones:



Eficiencia energética: de A+ a E

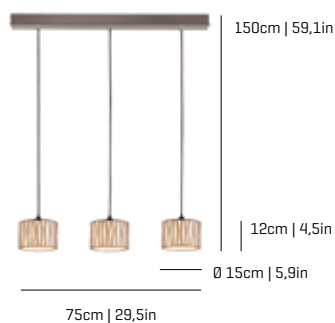

Curvas

by Arturo Álvarez

ref. CV04-3

615€

TULIPA

Vidrio
Un color a elegir

FLORÓN

Acero inoxidable

CABLE

Negro o transparente

230V - 50Hz

E14 - Max. 3x9 W

E14 ECO - Max. 3x46 W

E14 LED - Max. 3x7 W

E14 - Max. 3x60 W

 80x25x25 cm
31,5x9,8x9,8 in
5,3kg | 11,7lb

Certificaciones:



Eficiencia energética: de A+ a E

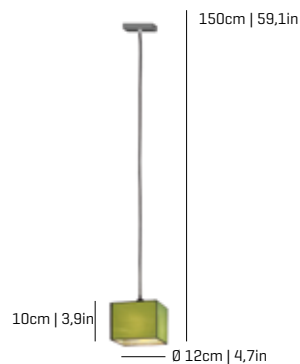

Doscubos

by Arturo Álvarez

ref. D004-1

145€

TULIPA

Vidrio
Un color a elegir





FLORÓN

Acero pintado
y acero inoxidable

CABLE

Negro o transparente

230V - 50Hz

-  E14 - Max. 1x9 W
-  E14 ECO - Max. 1x46 W
-  E14 LED - Max. 1x7 W
-  E14 - Max. 1x60 W

 20x20x20 cm
7,9x7,9x7,9 in
1kg | 2,2lb



Certificaciones:



Eficiencia energética: de A+ a E

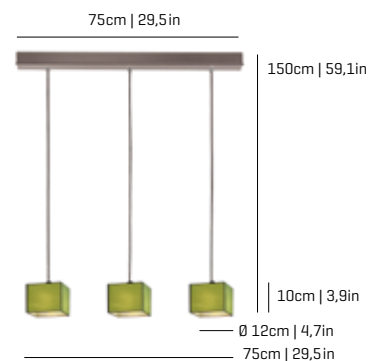

Doscubos

by Arturo Álvarez

ref. D004-3

437€

TULIPA

Vidrio
Un color a elegir





FLORÓN

Acero inoxidable

CABLE

Negro o transparente

230V - 50Hz

-  E14 - Max. 3x9 W
-  E14 ECO - Max. 3x46 W
-  E14 LED - Max. 3x7 W
-  E14 - Max. 3x60 W

 80x25x25 cm
31,5x9,8x9,8 in
4,8kg | 10,6lb



Certificaciones:



Eficiencia energética: de A+ a E

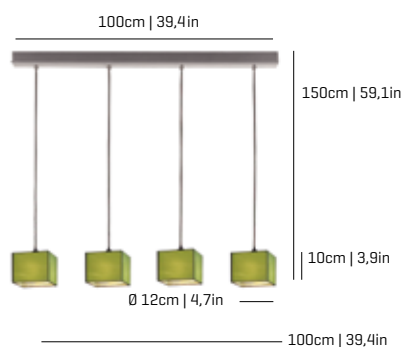

Doscubos

by Arturo Álvarez

ref. D004-4

519€

TULIPA

Vidrio
Un color a elegir





FLORÓN

Acero inoxidable

CABLE

Negro o transparente

230V - 50Hz

-  E14 - Max. 4x9 W
-  E14 ECO - Max. 4x46 W
-  E14 LED - Max. 4x7 W
-  E14 - Max. 4x60 W

 104x31x25 cm
40,9x12,2x9,8 in
6,6kg | 14,6lb



Certificaciones:



Eficiencia energética: de A+ a E

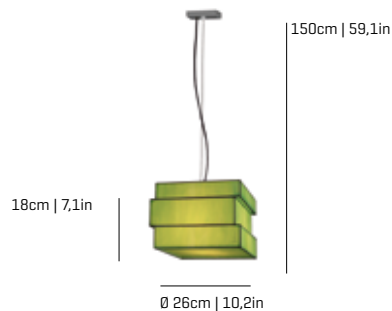

Encaixe

by Arturo Álvarez

ref. EN04

389€

TULIPA

Vidrio
Un color a elegir





FLORÓN

Acero pintado
y acero inoxidable

CABLE

Negro o transparente

230V - 50Hz

-  E27 - Max. 1x23 W
-  E27 ECO - Max. 1x77 W
-  E27 LED - Max. 1x12 W
-  E27 - Max. 1x100 W

 42x42x30 cm
16,5x16,5x11,8 in
4,3kg | 9,5lb



Certificaciones:



Eficiencia energética: de A+ a E

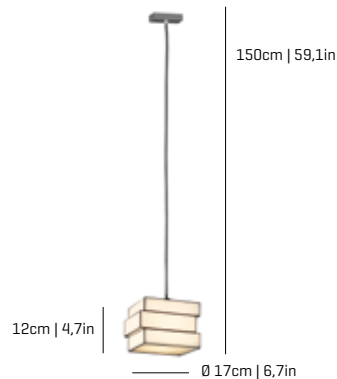

arturo alvarez

LÁMPARAS COLGANTES

PVP, IVA no incluido. Bombillas no incluidas

Encaixe

by Arturo Álvarez

ref. EN04-1

211€

TULIPA

Vidrio
Un color a elegir





FLORÓN

Acero pintado
y acero inoxidable

CABLE

Negro o transparente

230V - 50Hz

-  E14 - Max. 1x9 W
-  E14 ECO - Max. 1x46 W
-  E14 LED - Max. 1x7 W
-  E14 - Max. 1x60 W

 35x25x25 cm
13,8x9,8x9,8 in
1,8kg | 4lb



Certificaciones:

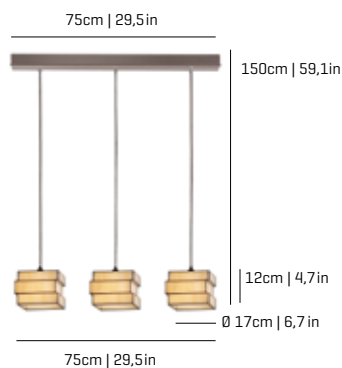

Encaixe

by Arturo Álvarez

ref. EN04-3

607€

TULIPA

Vidrio
Un color a elegir





FLORÓN

Acero inoxidable

CABLE

Negro o transparente

230V - 50Hz

-  E14 - Max. 3x9 W
-  E14 ECO - Max. 3x46 W
-  E14 LED - Max. 3x7 W
-  E14 - Max. 3x60 W

 80x25x25 cm
31,5x9,8x9,8 in
6,6kg | 14,6lb



Certificaciones:

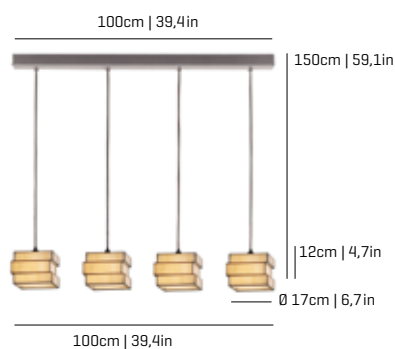

Encaixe

by Arturo Álvarez

ref. EN04-4

736€

TULIPA

Vidrio
Un color a elegir





FLORÓN

Acero inoxidable

CABLE

Negro o transparente

230V - 50Hz

-  E14 - Max. 4x9 W
-  E14 ECO - Max. 4x46 W
-  E14 LED - Max. 4x7 W
-  E14 - Max. 4x60 W

 104x31x25 cm
40,9x12,2x9,8 in
8,3kg | 18,3lb



Certificaciones:

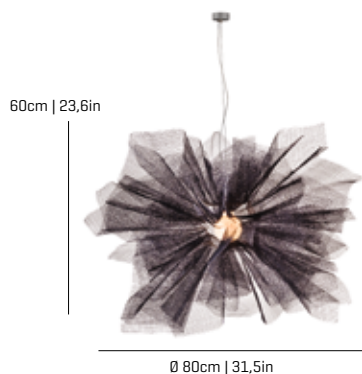

150cm | 59,1in

Fluo

by Arturo Álvarez

pg. 138 [Catálogo]

ref. FLO4

580€

TULIPA

Acero pintado galvanizado
Un color a elegir*



FLORÓN

Acero níquel-satinado
y acero inoxidable

CABLE

Negro o transparente

230V - 50Hz

-  E27 - Max. 1x23 W
-  E27 LED - Max. 1x11 W
-  E27 - Max. 1x100 W

 80x75x75 cm
31,5x29,5x29,5 in
6,5kg | 14,3lb



Certificaciones:



2009

arturo alvarez

LÁMPARAS COLGANTES

PVP, IVA no incluido. Bombillas no incluidas

**Gea** by Arturo Álvarez

pg. 40 [Catálogo]

ref. GE04

331€**TULIPA**SIMETECH® by arturo alvarez
pg.180 [Catálogo]

Un color a elegir





FLORÓN

Acero níquel-satinado

CABLE

Negro o transparente

230V - 50Hz

-  E27 - Max. 1x23 W
-  E27 ECO - Max. 1x77 W
-  E27 LED - Max. 1x12 W
-  E27 - Max. 1x100 W

Eficiencia energética: de A+ a E

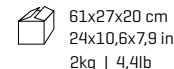

Certificaciones:

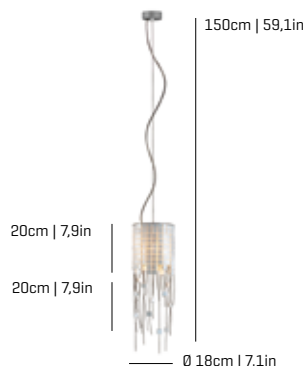
**Gilda** by Arturo Álvarez

ref. GD04-1B

535€**TULIPA**mosaico BISAZZA™
Un color

Acero inoxidable





FLORÓN

Acero níquel-satinado

CABLE

Transparente

230V - 50Hz

-  E14 - Max. 1x9 W
-  E14 - Max. 1x11 W
-  E14 ECO - Max. 1x46 W
-  E14 LED - Max. 1x7 W
-  E14 - Max. 1x60 W

Eficiencia energética: de A+ a E

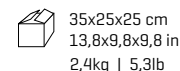

Certificaciones:

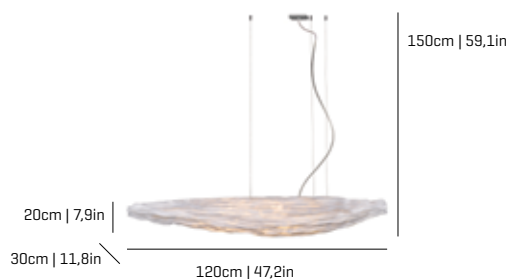
**Iki** by Arturo Álvarez

pg. 93 [Catálogo]

ref. IK04

677€**TULIPA**SIMETECH® by arturo alvarez
pg.180 [Catálogo]

Un color a elegir

Acero pintado





FLORÓN

Acero inoxidable

CABLE

Transparente

230V - 50Hz

-  E27 - Max. 2x23 W
-  E27 ECO - Max. 2x77 W
-  E27 LED - Max. 2x12 W
-  E27 - Max. 2x100 W

Eficiencia energética: de A+ a E

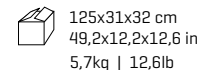

Certificaciones:

**Kite** by Arturo Álvarez

pg. 74 [Catálogo]

ref. KT04G: **846€** ref. KT04G-D*: **952€****TULIPA**SIMETECH® by arturo alvarez
pg.180 [Catálogo]

Un color a elegir

Acero pintado

FLORÓN

Acero inoxidable

CABLE

Transparente

*Regulable

230V - 50Hz

G5 - Max. 4x24 W

Posibilidad bombillas de color 

Eficiencia energética: de A a B

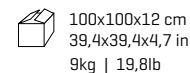

Certificaciones:



arturo alvarez

LÁMPARAS COLGANTES

PVP, IVA no incluido. Bombillas no incluidas

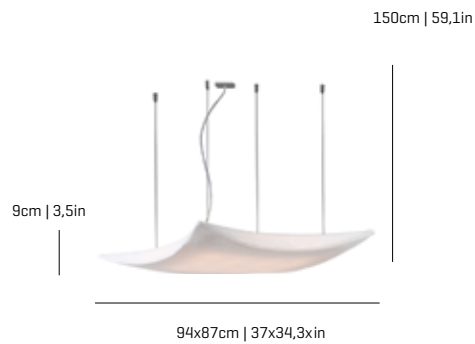

Kite

by Arturo Álvarez

pg. 74 [Catálogo]

ref. KT04: **731€** ref. KT04-D*: **768€**

TULIPA

SIMETECH® by arturo alvarez
pg.180 [Catálogo]

Un color a elegir

Acero pintado

FLORÓN

Acero inoxidable

CABLE

Transparente

*Regulable

230V - 50Hz

26X13 - Max. 1x55 W

Eficiencia energética: de A a B

71x71x13 cm
28x28x5,1 in
3kg | 6,6lb

Certificaciones:

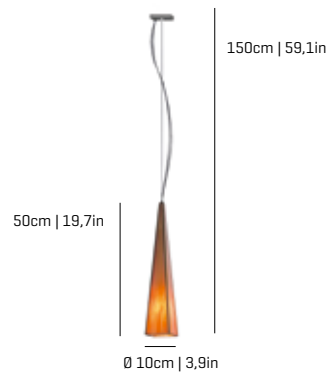

Kono

by Arturo Álvarez

ref. KN04-1

268€

TULIPA

Vidrio
Un color a elegir

FLORÓN

Acero pintado
y acero inoxidable

CABLE

Negro o transparente

230V - 50Hz

E14 - Max. 1x11 W

E14 ECO - Max. 1x46 W

E14 LED - Max. 1x7 W

E14 - Max. 1x60 W

Eficiencia energética: de A+ a E

60x25x20 cm
23,6x9,8x7,9 in
2,2kg | 4,9lb

Certificaciones:

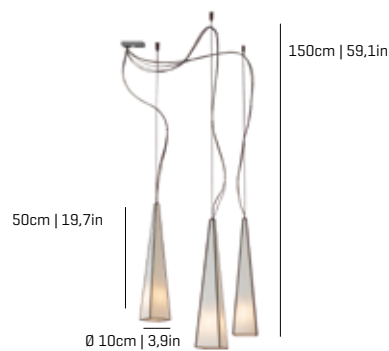

Kono

by Arturo Álvarez

ref. KN04-3

622€

TULIPA

Vidrio
Un color a elegir

FLORÓN

Acero pintado
y acero inoxidable

CABLE

Negro o transparente

230V - 50Hz

E14 - Max. 3x11 W

E14 ECO - Max. 3x46 W

E14 LED - Max. 3x7 W

E14 - Max. 3x60 W

Eficiencia energética: de A+ a E

60x30x20 cm
23,6x11,8x7,9 in
4,5kg | 9,9lb

Certificaciones:

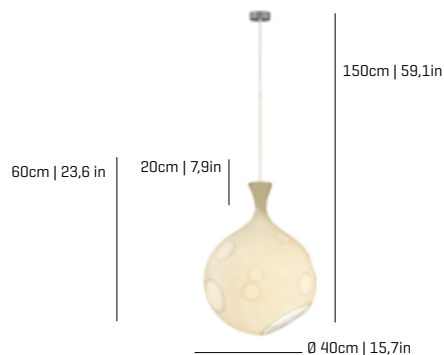

Lua

by Martín Azúa

pg. 173 [Catálogo]

ref. LU04

293€

TULIPA

Poliuretano
Un color

FLORÓN

Acero níquel-satinado

CABLE

Transparente

230V - 50Hz

E27 - Max. 1x23 W

E27 LED - Max. 1x12 W

Eficiencia energética: de A a B

43x43x63 cm
16,9x16,9x24,8 in
4,1kg | 9lb

Certificaciones:



arturo alvarez

LÁMPARAS COLGANTES

PVP, IVA no incluido. Bombillas no incluidas

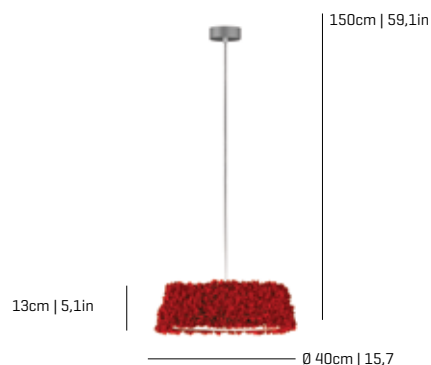

Miuu

by Arturo Álvarez pg. 162 [Catálogo]

ref. M104: **566€** ref. M104-D*: **671€**

TULIPA

Tela
Uno o dos colores a elegir

FLORÓN

Acero níquel-satinado

230V - 50Hz

2GX13 - Max. 1x22 W

 42x42x20 cm
16,5x16,5x7,9 in
2,7kg | 6lb

CABLE

Negro o transparente

Eficiencia energética: de A a B

Acero pintado:

blanco: con tulipas en color blanco o gris
o con combinación de: blanco+otro color
negro: con tulipas en color negro, rojo, granate o verde,
o con combinaciones de: negro+otro color

Difusor superior e inferior

*Regulable



Certificaciones:



Miuu

by Arturo Álvarez pg. 162 [Catálogo]

ref. M104G: **773€** ref. M104G-D*: **846€**

TULIPA

Tela
Uno o dos colores a elegir

FLORÓN

Acero pintado

230V - 50Hz

2GX13 - Max. 1x55 W

 61x61x20 cm
24x24x7,9 in
6,2kg | 13,8lb

CABLE

Negro o transparente

Eficiencia energética: de A a B

Acero pintado

blanco: con tulipas en color blanco o gris
o con combinación de: blanco+otro color
negro: con tulipas en color negro, rojo, granate o verde,
o con combinaciones de: negro+otro color

Difusor superior e inferior

*Regulable



Certificaciones:

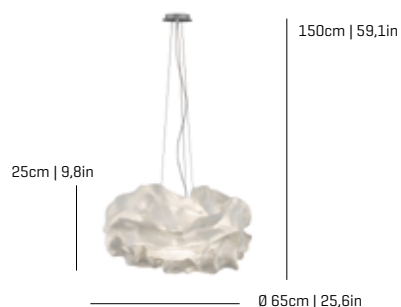

Nevo

by Arturo Álvarez pg. 60 [Catálogo]

ref. NE04

565€

TULIPA

SIMETECH® by arturo alvarez
pg.180 [Catálogo]

Un color a elegir

FLORÓN

Acero níquel-satinado
y acero inoxidable

230V - 50Hz

E27 - Max. 3x23 W

E27 ECO - Max. 3x77 W

E27 LED - Max. 3x12 W

E27 - Max. 3x100 W

 60x61x21 cm
23,6x24x8,3 in
4,3kg | 9,5lb

CABLE

Transparente

Eficiencia energética: de A+ a E

Acero níquel-satinado
y acero inoxidable

Certificaciones:

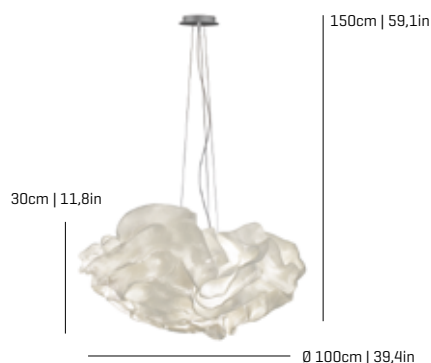

Nevo

by Arturo Álvarez pg. 62 [Catálogo]

ref. NE04G

1130€

TULIPA

SIMETECH® by arturo alvarez
pg.180 [Catálogo]

Un color a elegir

FLORÓN

Acero níquel-satinado
y acero inoxidable

230V - 50Hz

E27 - Max. 4x23 W

E27 ECO - Max. 4x77 W

E27 LED - Max. 4x12 W

E27 - Max. 4x100 W

 84x84x37 cm
33,1x33,1x14,6 in
8,6kg | 18,9lb

CABLE

Transparente

Eficiencia energética: de A+ a E

Acero níquel-satinado
y acero inoxidable

Certificaciones:



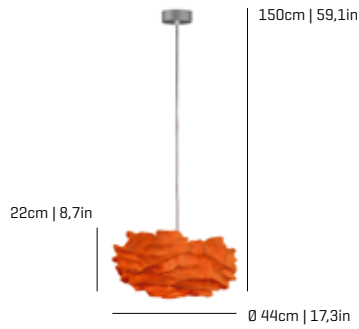

Nevo

by Arturo Álvarez

pg. 61 [Catálogo]

ref. NE04-1

370€

TULIPA

SIMETECH® by arturo alvarez
pg.180 [Catálogo]

Un color a elegir

Acero niquel-satinado
y acero inoxidable

FLORÓN

Acero niquel-satinado

CABLE

Transparente

230V - 50Hz

- E14 - Max. 2x9 W
- E14 - Max. 2x11 W
- E14 ECO - Max. 2x46 W
- E14 LED - Max. 2x7 W
- E14 - Max. 2x60 W

Eficiencia energética: de A+ a E

 43x43x18 cm
16,9x16,9x7,1 in
2,1kg | 4,5lb

Certificaciones:



Nevo

by Arturo Álvarez

pg. 64 [Catálogo]

ref. NE04-6

2329€

TULIPA

SIMETECH® by arturo alvarez
pg.180 [Catálogo]

Un color a elegir

Acero niquel-satinado
y acero inoxidable3 TULIPAS ref. NE06P
3 TULIPAS ref. NE04-1

FLORÓN

DIBOND®

CABLE

Transparente

230V - 50Hz

- E14-MAX 12x9 W
- E14-MAX 12x11 W
- E14 ECO-MAX 12x46 W
- E14 LED-MAX 12x7 W
- E14-MAX 12x60 W

Eficiencia energética: de A+ a E

 60x80x82 cm
23,6x31,5x32,3 in
25kg | 55,1lb

Certificaciones:

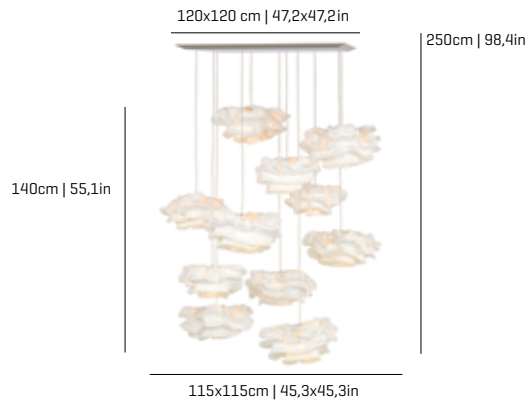

Nevo

by Arturo Álvarez

pg. 65 [Catálogo]

ref. NE04-11

4335€

TULIPA

SIMETECH® by arturo alvarez
pg.180 [Catálogo]

Un color a elegir

Acero niquel-satinado
y acero inoxidable4 TULIPAS ref. NE06P
7 TULIPAS ref. NE04-1

FLORÓN

DIBOND®

CABLE

Transparente

230V - 50Hz

- E14-MAX 22x9 W
- E14-MAX 22x11 W
- E14 ECO-MAX 22x46 W
- E14 LED-MAX 22x7 W
- E14-MAX 22x60 W

Eficiencia energética: de A+ a E

 80x120x135 cm
31,5x47,2x53,1 in
53kg | 116,8lb

Certificaciones:

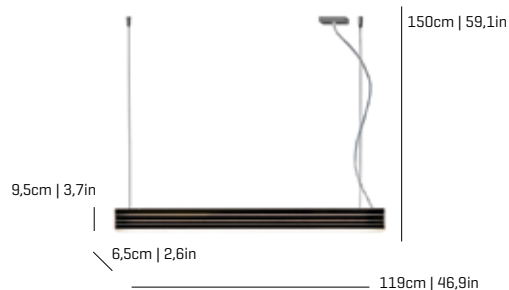

Norman

by Arturo Álvarez

pg. 130 [Catálogo]

ref. N004

740€

TULIPA

Vidrio
Un color a elegir*

Acero

*Excepto color 95. Beige

FLORÓN

Acero inoxidable

CABLE

Negro o transparente

230V - 50Hz

- G5 - Max. 1x54 W

Eficiencia energética: de A a B

 145x20x20 cm
57,1x7,9x7,9 in
6,5kg | 14,3lb

Certificaciones:



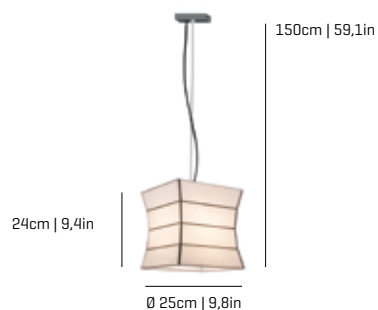

Senda

by Arturo Álvarez

TULIPA

Vidrio
Un color a elegir

FLORÓN







Acero níquel-satinado

CABLE

Negro o transparente

ref. **SN04****399€**

230V - 50Hz

-  E27 - Max. 1x23 W
-  E27 - Max. 1x23 W
-  E27 LED - Max. 1x14 W
-  E27 ECO - Max. 1x77 W
-  E27 LED - Max. 1x12 W
-  E27 - Max. 1x100 W

 42x42x30 cm
16,5x16,5x11,8 in
3,4kg | 7,5lb



Certificaciones:



Eficiencia energética: de A+ a E

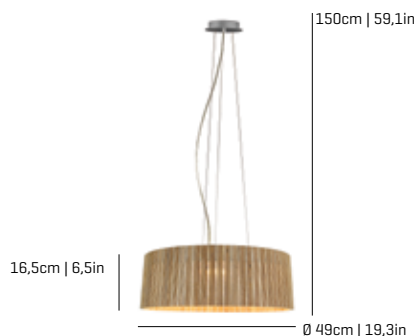

Shio

by Arturo Álvarez

pg. 142 [Catálogo]

ref. **SH04: 644€****SH04-D*: 691€**

TULIPA

Tablero marino
Un color a elegir

Acero pintado

FLORÓN

Acero níquel-satinado
y acero inoxidable

CABLE

Negro o transparente

Difusor superior e inferior

*Regulable

230V - 50Hz

-  2GX13 - Max. 1x55 W

Eficiencia energética: de A a B

 61x61x21 cm
24x24x8,3 in
7,1kg | 15,5lb



Certificaciones:



Shio

by Arturo Álvarez

pg. 142 [Catálogo]

ref. **SH04-1: 457€**ref. **SH04-1-D*: 502€**

TULIPA

Tablero marino
Un color a elegir

Acero pintado

Difusor superior e inferior

FLORÓN

Acero níquel-satinado
y acero inoxidable

CABLE

Negro o transparente

*Regulable

230V - 50Hz

-  2GX13 - Max. 1x22 W

Eficiencia energética: de A a B

 43x43x18 cm
16,9x16,9x7,1 in
4,2kg | 9,1lb



Certificaciones:



Tati

by Arturo Álvarez

pg. 47 [Catálogo]

ref. **TA04****555€**

TULIPA

SIMETECH® by arturo alvarez
pg.180 [Catálogo]

Un color a elegir

Acero níquel-satinado
y acero inoxidable





FLORÓN

Acero níquel-satinado
y acero inoxidable

CABLE

Negro o transparente

230V - 50Hz

-  E27 - Max. 3x23 W
-  E27 ECO - Max. 3x77 W
-  E27 LED - Max. 3x12 W
-  E27 - Max. 3x100 W

Eficiencia energética: de A+ a E

 60x60x20 cm
23,6x23,6x7,9 in
4kg | 8,8lb



Certificaciones:





Tati

by Arturo Álvarez

pg. 46 [Catálogo]

ref. TA04G

1079€

TULIPA

SIMETECH® by arturo alvarez
pg.180 [Catálogo]

Un color a elegir

Acero niquel-satinado
y acero inoxidable





FLORÓN

Acero niquel-satinado
y acero inoxidable

CABLE

Negro o transparente

230V - 50Hz

-  E27 - Max. 4x23 W
-  E27 ECO - Max. 4x77 W
-  E27 LED - Max. 4x12 W
-  E27 - Max. 4x100 W

Eficiencia energética: de A+ a E

 100x88x23cm
39,4x34,6x9,1 in
9kg | 19,8lb

Certificaciones:



Tati

by Arturo Álvarez

pg. 47 [Catálogo]

ref. TA04-1

369€

TULIPA

SIMETECH® by arturo alvarez
pg.180 [Catálogo]

Un color a elegir

Acero niquel-satinado
y acero inoxidable







FLORÓN

Acero niquel-satinado
y acero inoxidable

CABLE

Negro o transparente

230V - 50Hz

-  E27 - Max. 1x23 W
-  E27 - Max. 1x23 W
-  E27 LED - Max. 1x11 W
-  E27 ECO - Max. 1x77 W
-  E27 LED - Max. 1x12 W
-  E27 - Max. 1x100 W

Eficiencia energética: de A+ a E

 52x47x21 cm
20,5x18,5x8,3 in
3kg | 6,6lb

Certificaciones:

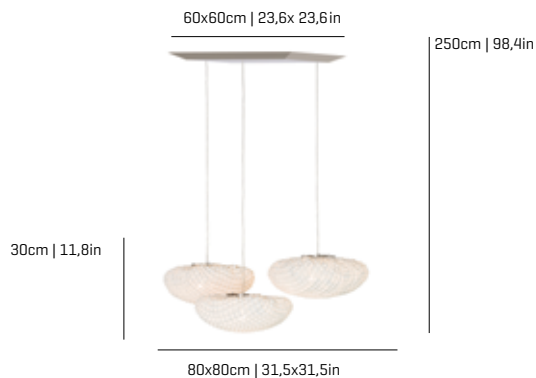

Tati

by Arturo Álvarez

pg. 48 [Catálogo]

ref. TA04-3

1613€

TULIPA

SIMETECH® by arturo alvarez
pg.180 [Catálogo]

Un color a elegir

Acero niquel-satinado
y acero inoxidable

3 TULIPAS ref. TA06G





FLORÓN

DIBOND®

CABLE

Transparente

230 V - 50Hz

-  E14-MAX 6x9 W
-  E14-MAX 6x11 W
-  E14 ECO-MAX 6x46 W
-  E14 LED-MAX 6x7 W
-  E14-MAX 6x60 W

Eficiencia energética: de A+ a E

 60x80x82 cm
23,6x31,5x32,3 in
19kg | 41,9lb

Certificaciones:



Tati

by Arturo Álvarez

pg. 49 [Catálogo]

ref. TA04-5

2225€

TULIPA

SIMETECH® by arturo alvarez
pg.180Un color a elegir o
combinación de dos coloresAcero niquel-satinado
y acero inoxidable3 TULIPAS ref. TA06G
2 TULIPAS ref. TA06P





FLORÓN

DIBOND®

CABLE

Transparente

230 V - 50Hz

-  E14-MAX 10x9 W
-  E14-MAX 10x11 W
-  E14 ECO-MAX 10x46 W
-  E14 LED-MAX 10x7 W
-  E14-MAX 10x60 W

Eficiencia energética: de A+ a E

 60x80x82 cm
23,6x31,5x32,3 in
25kg | 55,1lb

Certificaciones:



arturo alvarez

LÁMPARAS COLGANTES

PVP, IVA no incluido. Bombillas no incluidas

Tati

by Arturo Álvarez

pg. 50 [Catálogo]

ref. TA04-10

4405€

TULIPA

SIMETECH® by arturo alvarez
pg.180 [Catálogo]Un color a elegir o
combinación de dos coloresAcero níquel-satinado
y acero inoxidable6 TULIPAs ref. TA06G
4 TULIPAs ref. TA06P





FLORÓN

DIBOND®

CABLE

Transparente

230 V - 50Hz

-  E14-MAX 20x9 W
-  E14-MAX 20x11 W
-  E14 ECO-MAX 20x46 W
-  E14 LED-MAX 20x7 W
-  E14-MAX 20x60 W

Eficiencia energética: de A+ a E

80x120x135 cm
31,5x47,2x53,1 in
55kg | 121,3lb

Certificaciones:

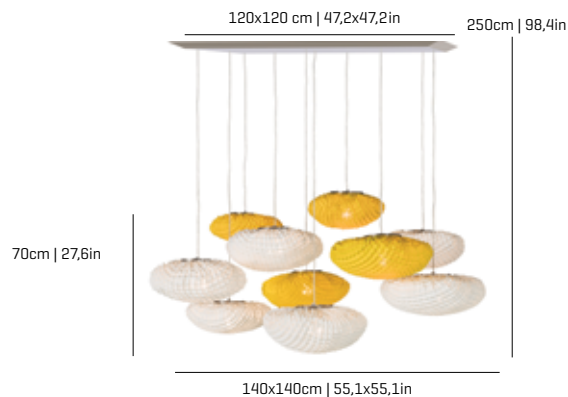

Tina

by Arturo Álvarez

pg. 106 [Catálogo]

ref. TN04

423€

TULIPA

Polipropileno
Un color a elegir

Acero pintado







FLORÓN

Acero níquel-satinado

CABLE

Negro o transparente

230V - 50Hz

-  E27 - Max. 1x23 W
-  E27 - Max. 1x23 W
-  E27 LED - Max. 1x11 W
-  E27 ECO - Max. 1x116 W
-  E27 LED - Max. 1x12 W
-  E27 - Max. 1x100 W

Eficiencia energética: de A+ a E

104x31x25 cm
40,9x12,2x9,8 in
3,8kg | 8,3lb

Certificaciones:



Tina

by Arturo Álvarez

pg. 106 [Catálogo]

ref. TN04G

460€

TULIPA

Polipropileno
Un color a elegir

Acero pintado







FLORÓN

Acero níquel-satinado

CABLE

Negro o transparente

230V - 50Hz

-  E27 - Max. 1x23 W
-  E27 - Max. 1x23 W
-  E27 LED - Max. 1x11 W
-  E27 ECO - Max. 1x116 W
-  E27 LED - Max. 1x12 W
-  E27 - Max. 1x100 W

Eficiencia energética: de A+ a E

111x31x25 cm
43,7x12,2x9,8 in
4,1kg | 9lb

Certificaciones:



Tina

by Arturo Álvarez

pg. 108 [Catálogo]

ref. TN04-5

2623€

TULIPA

Polipropileno
Un color a elegir

Acero pintado

refs. 5xTN04







FLORÓN

DIBOND®

CABLE

Transparente

230V - 50Hz

-  E27 - Max. 5x23 W
-  E27 - Max. 5x23 W
-  E27 LED - Max. 5x11 W
-  E27 ECO - Max. 5x116 W
-  E27 LED - Max. 5x12 W
-  E27 - Max. 5x100 W

Eficiencia energética: de A+ a E

80x120x135 cm
31,5x47,2x53,1 in
38kg | 83,8lb

Certificaciones:

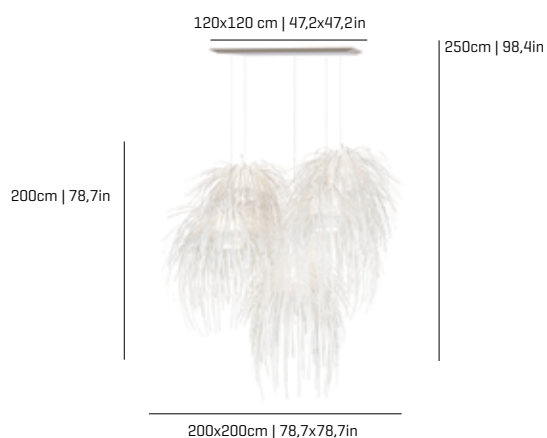

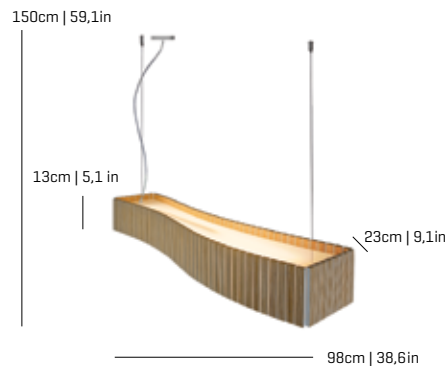
**arturo alvarez**

LÁMPARAS COLGANTES

PVP, IVA no incluido. Bombillas no incluidas

Uxi by Arturo Álvarez

pg. 147 [Catálogo]

ref. UX04: **779€** ref. UX04-D*: **831€****TULIPA**Tablero marino
Un color a elegir

Difusor inferior e interior

FLORÓN

Acero inoxidable

CABLE

Negro o transparente

*Regulable

230V - 50Hz

G5 - Max. 2x39 W

Eficiencia energética: de A a B104x31x25 cm
40,9x12,2x9,8 in
7,7kg | 17lb

Certificaciones:

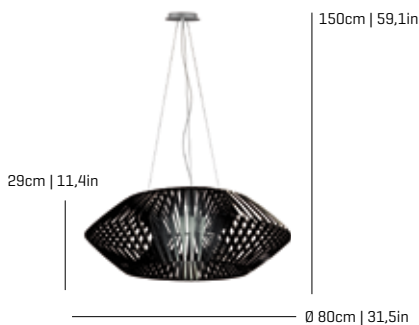
**V** by Héctor Serrano

pg. 166 [Catálogo]

ref. VV04

794€**TULIPA**Policarbonato
Un color a elegir

Difusor de vidrio

FLORÓNAcero niquel-satinado
y acero inoxidable**CABLE**

Negro o transparente

230V - 50Hz

E27 - Max. 1x23 W

E27 ECO - Max. 1x77 W

E27 LED - Max. 1x12 W

E27 - Max. 1x100 W

Eficiencia energética: de A+ a E83x85x38 cm
32,7x33,5x15 in
8,2kg | 18lb

Certificaciones:

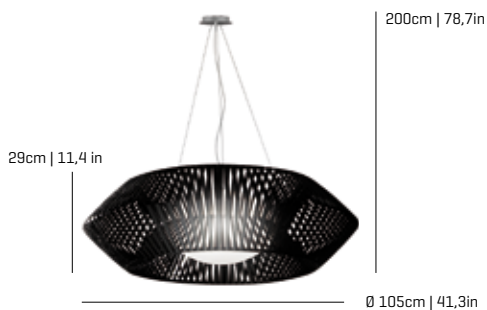
**V** by Héctor Serrano

pg. 166 [Catálogo]

ref. VV04G

1383€**TULIPA**Policarbonato
Un color a elegir

Difusor de vidrio

FLORÓNAcero niquel-satinado
y acero inoxidable**CABLE**

Negro o transparente

230V - 50Hz

E27 - Max. 4x23 W

E27 ECO - Max. 4x77 W

E27 LED - Max. 4x12 W

E27 - Max. 4x100 W

Eficiencia energética: de A+ a E110x107x32 cm
43,3x42,1x12,6 in
9,7kg | 21,4lb
61x61x32 cm
24x24x12,6 in
10,6kg | 23,4lb

Certificaciones:

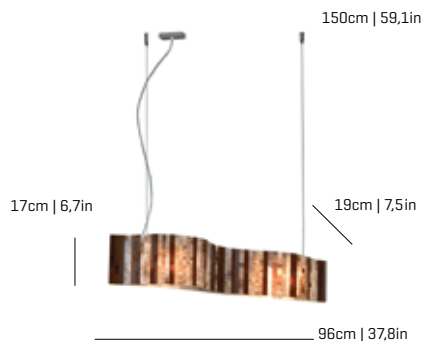
**Vento** by Arturo Álvarez

pg. 118 [Catálogo]

ref. VN04: **996€** ref. VN04-L*: **1129€****TULIPA**Vidrio
Un color a elegir
o combinaciones:
Rosa
Marrón
BN

BN

FLORÓN

Acero inoxidable

CABLE

Negro o transparente

230V - 50Hz

G9 LED - Max. 4x3 W

G9 ECO - Max. 4x42 W [Philips]

G9 ECO - Max. 4x33 W [Osram]

*LED - 1x21,6 W - 1735Lm - 3.000K

Eficiencia energética: de A+ a C***Eficiencia energética:** de A++ a A125x32x32 cm
49,2x12,6x12,6 in
9,4kg | 20,7lb

Certificaciones:



AVISO IMPORTANTE: Las colecciones VENTO y VENTOPOP sólo son aptas para uso con bajo consumo G9 o halógenas G9 ECO

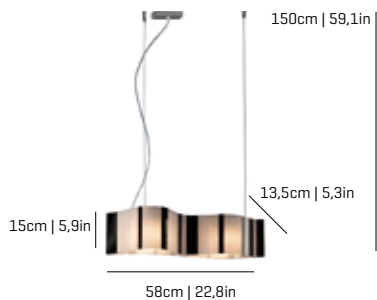

Vento

by Arturo Álvarez

pg. 119 [Catálogo]

ref. VN04-1

685€

TULIPA

Vidrio

Un color a elegir
o combinaciones:Rosa
Marrón
B&N

FLORÓN

Acero inoxidable

CABLE

Negro o transparente

230V - 50Hz

G9 LED - Max. 2x3 W

G9 ECO - Max. 2x42 W (Philips)

G9 ECO - Max. 2x33 W (Osram)

80x30x30 cm
31,5x11,8x11,8 in
3,7kg | 8,2lb

Eficiencia energética: de A+ a C

Certificaciones:



AVISO IMPORTANTE: Las colecciones VENTO y VENTOPOP sólo son aptas para uso con bajo consumo G9 o halógenas G9 ECO

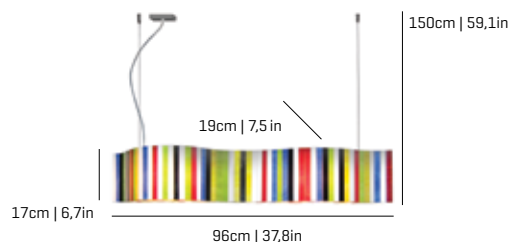

Ventopop

by Arturo Álvarez

ref. VN04POP: **1057€**ref. VN04POP-L*: **1199€**

TULIPA

Vidrio

Colores combinación POP

pg. 120 [Catálogo]

FLORÓN

Acero inoxidable

CABLE

Negro o transparente

230V - 50Hz

G9 LED - Max. 4x3 W

G9 ECO - Max. 4x42 W (Philips)

G9 ECO - Max. 4x33 W (Osram)

*LED - 1x21,6 W - 1735Lm - 3.000K

125x32x32 cm
49,2x12,6x12,6 in
9,4kg | 20,7lb

Eficiencia energética: de A+ a C

*Eficiencia energética: de A++ a A

Certificaciones:



AVISO IMPORTANTE: Las colecciones VENTO y VENTOPOP sólo son aptas para uso con bajo consumo G9 o halógenas G9 ECO



Ventopop

by Arturo Álvarez

pg. 122 [Catálogo]

ref. VN041POP

728€

TULIPA

Vidrio

Colores combinación POP

FLORÓN

Acero inoxidable

CABLE

Negro o transparente

230V - 50Hz

G9 LED - Max. 2x3 W

G9 ECO - Max. 2x42 W (Philips)

G9 ECO - Max. 2x33 W (Osram)

80x31x31 cm
31,5x11,8x11,8 in
3,7kg | 8,3lb

Eficiencia energética: de A+ a C

Certificaciones:



AVISO IMPORTANTE: Las colecciones VENTO y VENTOPOP sólo son aptas para uso con bajo consumo G9 o halógenas G9 ECO



Woods

by Héctor Serrano

pg. 153 [Catálogo]

ref. WD04

1225€

TULIPA

Abedul

Difusor de vidrio

FLORÓN

Acero pintado

CABLE

Transparente

230V - 50Hz

E27 - Max. 1x23 W

E27 ECO - Max. 1x77 W

E27 LED - Max. 1x12 W

E27 - Max. 1x100 W

60x60x30 cm
23,6x23,6x11,8 in
15kg | 33,1lb

Eficiencia energética: de A+ a E

Certificaciones:



APLIQUES Y PLAFONES

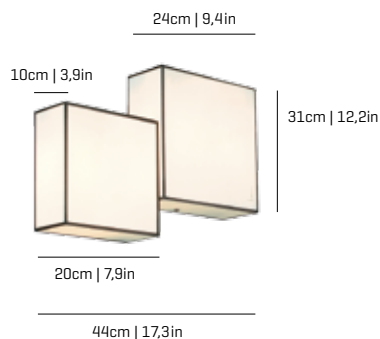

Apliques

by Arturo Álvarez

ref. A0501

519€

TULIPA

Vidrio
Un color a elegir

SOPORTE

Acero inoxidable

230V - 50Hz

G24d1 - Max. 4x13 W

Eficiencia energética: de A a B

 50x45x20 cm
19,7x17,7x7,9 in
6,2kg | 13,7lb

Certificaciones:

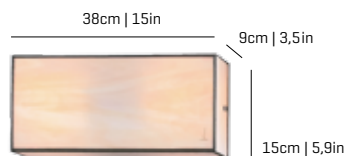

Apliques

by Arturo Álvarez

ref. A0604

218€

TULIPA

Vidrio
Un color a elegir

SOPORTE

Acero inoxidable

230V - 50Hz

E14 - Max. 2x11 W

E14 ECO - Max. 2x46 W

E14 LED - Max. 2x7 W

E14 - Max. 2x60 W

Eficiencia energética: de A+ a E

 50x20x25 cm
19,7x7,9x9,8 in
1,5kg | 3,3lb

Certificaciones:

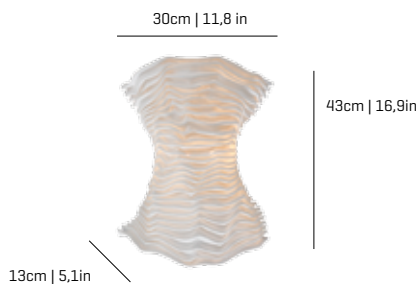

Cors

by Arturo Álvarez

pg. 70 [Catálogo]

ref. CRO6

198€

TULIPA

SIMETECH® by arturo alvarez
pg.180 [Catálogo]

Un color a elegir

SOPORTE

Acero pintado

230V - 50Hz

G9 LED - Max. 2x3 W

G9 ECO - Max. 2x42 W

G9 - Max. 2x60 W

Eficiencia energética: de A+ a C

 51x26x20 cm
20,1x10,2x7,9 in
1kg | 2,2lb

Certificaciones:



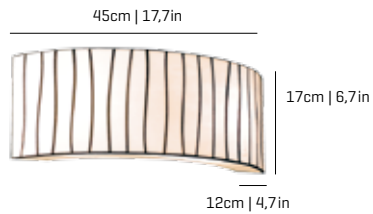

Curvas

by Arturo Álvarez

ref. CV06

317€





TULIPA

Vidrio
Un color a elegir

SOPORTE

Acero inoxidable

230V - 50Hz

-  E14 - Max. 2x11 W
-  E14 ECO - Max. 2x46 W
-  E14 LED - Max. 2x7 W
-  E14 - Max. 2x60 W

Eficiencia energética: de A+ a E

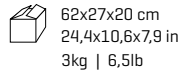

Certificaciones:

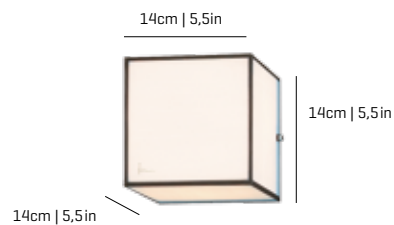

Doscubos

by Arturo Álvarez

ref. D006G

208€



TULIPA

Vidrio
Un color a elegir

SOPORTE

Acero inoxidable

230V - 50Hz

-  G9 LED - Max. 1x3 W
-  G9 ECO - Max. 1x42 W
-  G9 - Max. 1x40 W

Eficiencia energética: de A+ a C

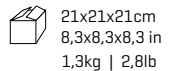

Certificaciones:

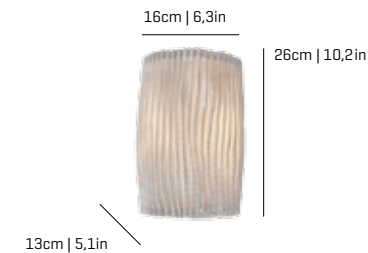

Gea

by Arturo Álvarez

pg. 41 [Catálogo]

ref. GE06

193€

TULIPA



SIMETECH® by arturo alvarez
pg.180 [Catálogo]

Un color a elegir

SOPORTE

Acero pintado

230V - 50Hz

-  G9 LED - Max. 2x3 W
-  G9 ECO - Max. 2x42 W
-  G9 - Max. 2x60 W

120V - 60Hz

-  G9 Bi-pin - Max. 2x60 W

Eficiencia energética: de A+ a C

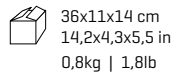

Certificaciones:

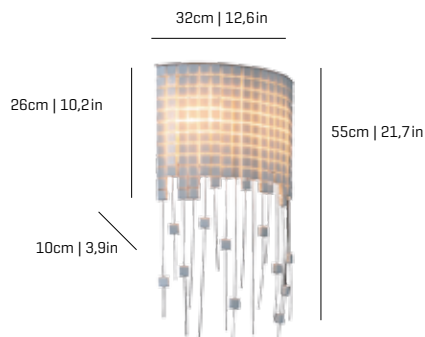

Gilda

by Arturo Álvarez

ref. GD06-BB

552€

TULIPA

Mosaico BISAZZA™
Un color

SOPORTE

Acero inoxidable

230V - 50Hz

-  G24d2 - Max. 2x18 W

Eficiencia energética: de A a B

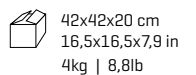

Certificaciones:



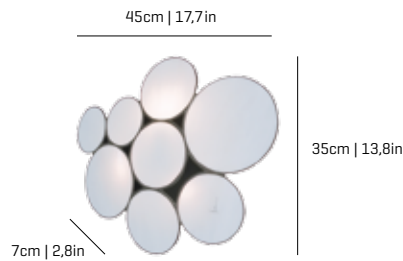

Gluc

by Arturo Álvarez

pg. 134 [Catálogo]

ref. GL06

387€

TULIPA

Vidrio

Uno o dos colores a elegir

SOPORTE

Acero inoxidable

230V - 50Hz

G9 LED - Max. 3x3 W

G9 ECO - Max. 3x42 W

G9 - Max. 3x40 W

 61x61x31 cm
24x24x12,2 in
4kg | 8,8lb

Eficiencia energética: de A+ a C



Certificaciones:

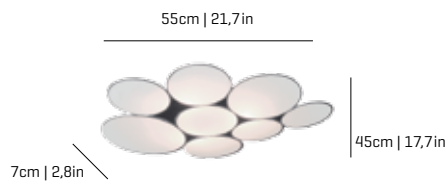

Gluc

by Arturo Álvarez

pg. 135 [Catálogo]

ref. GL05

417€

TULIPA

Vidrio

Uno o dos colores a elegir

SOPORTE

Acero inoxidable

230V - 50Hz

G9 LED - Max. 3x3 W

G9 ECO - Max. 3x42 W

G9 - Max. 3x40 W

 61x61x31 cm
24x24x12,2 in
5,4kg | 11,9lb

Eficiencia energética: de A+ a C



Certificaciones:

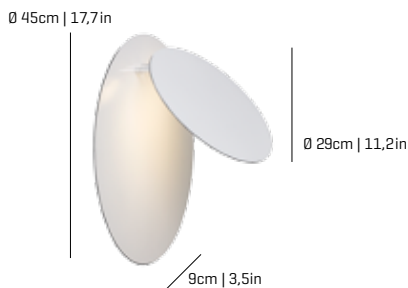

Guau

by El Último Grito

pg. 169 [Catálogo]

ref. GU06

416€

TULIPA

DIBOND®

Un color

SOPORTE

Acero pintado

230V - 50Hz

GX53 - Max. 3x9 W

GX53 LED - Max. 3x5 W

Posibilidad bombillas de color

 50x45x20 cm
19,7x17,7x7,9 in
3,4kg | 7,4lb

Eficiencia energética: de A a B



Certificaciones:

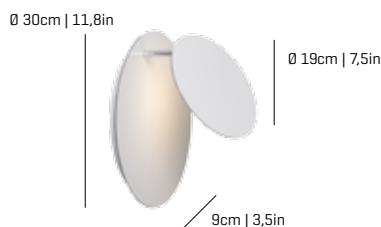

Guau

by El Último Grito

ref. GU06P

345€

TULIPA

DIBOND®

Un color

SOPORTE

Acero pintado

230V - 50Hz

GX53 - Max. 1x13 W

GX53 LED - Max. 1x5 W

Posibilidad bombillas de color

 44x44x18 cm
17,3x17,3x7,1 in
1,7 | 3,7lb

Eficiencia energética: de A a B



Certificaciones:

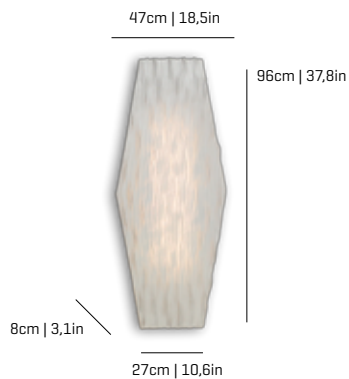

Hexa

by Arturo Álvarez

ref. HE06: **611€** ref. HE06-D*: **714€**

TULIPA
SIMETECH® by arturo alvarez
pg.180 [Catálogo]

Un color a elegir

SOPORTE
Acero inoxidable

*Regulable

230V - 50Hz
G5 - Max. 2x24 W
Posibilidad bombillas de color

100x50x12 cm
39,4x19,7x4,7 in
4,5kg | 9,9lb

Eficiencia energética: de A a B



Certificaciones:

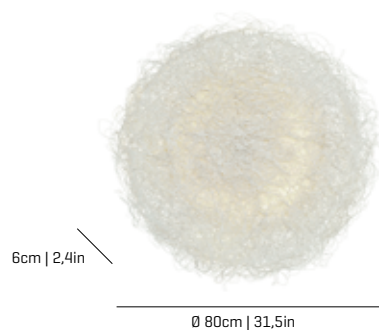

Icarus

by Arturo Álvarez

pg. 18 [Catálogo]

ref. IC06

771€

TULIPA
Cordón
Un color a elegir

SOPORTE
Acero inoxidable

230V - 50Hz
LED - 1x45 W - 3.615Lm - 3.000K

100x101x12 cm
39,4x39,8x4,7 in
6kg | 13,2lb

Eficiencia energética: de A++ a A



Certificaciones:

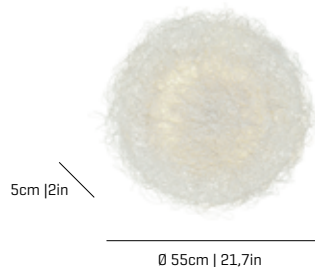

Icarus

by Arturo Álvarez

pg. 19 [Catálogo]

ref. IC06P

663€

TULIPA
Cordón
Un color a elegir

SOPORTE
Acero inoxidable

230V - 50Hz
LED - 1x36 W - 2.892Lm - 3.000K

71x71x15 cm
28x28x5,9 in
4,8kg | 10,6lb

Eficiencia energética: de A++ a A



Certificaciones:

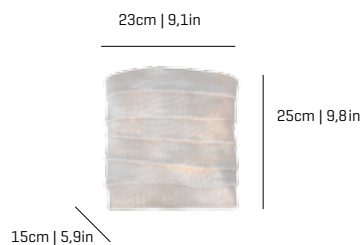

Kala

by Arturo Álvarez

pg. 91 [Catálogo]

ref. KL06

199€

TULIPA
SIMETECH® by arturo alvarez
pg.180 [Catálogo]

Un color a elegir

SOPORTE
Acero pintado

230V - 50Hz
G9 LED - Max. 2x3 W
G9 ECO - Max. 2x42 W
G9 - Max. 2x60 W

33x24x15 cm
13x9,4x5,9 in
1kg | 2,1lb

Eficiencia energética: de A+ a C



Certificaciones:



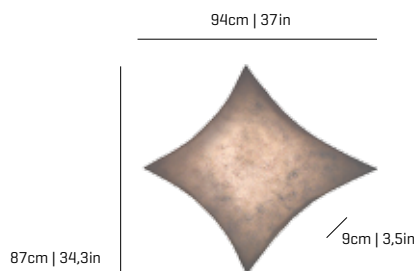

Kite

by Arturo Álvarez

pg. 75 [Catálogo]

ref. KT06: **594€**ref. KT06-D*: **625€**

TULIPA

SIMETECH® by arturo alvarez
pg.180 [Catálogo]

Un color a elegir

SOPORTE

Acero pintado

*Regulable

230V - 50Hz

2GX13 - Max. 1x55 W

Eficiencia energética: de A a B

 71x71x15 cm
28x28x5,9 in
5,9kg | 13lb

Certificaciones:

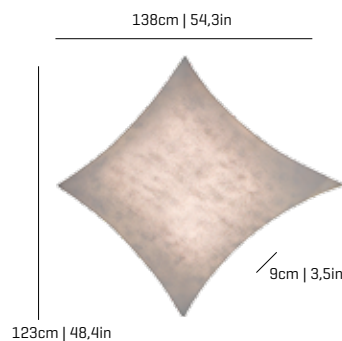

Kite

by Arturo Álvarez

pg. 75 [Catálogo]

ref. KT06G: **794€**ref. KT06G-D*: **858€**

TULIPA

SIMETECH® by arturo alvarez
pg.180 [Catálogo]

Un color a elegir

SOPORTE

Acero pintado

*Regulable

230V - 50Hz

G5 - Max. 4x24 W

Posibilidad bombillas
de color

Eficiencia energética: de A a B

 100x101x12 cm
39,4x39,8x4,7 in
10kg | 22lb

Certificaciones:



Li

by Arturo Álvarez

pg. 156 [Catálogo]

ref. LI06

370€

TULIPA

Celulosa prensada
Un color a elegir

SOPORTE

Acero inoxidable

230V - 50Hz

LED - 1x9 W - 723Lm - 3000K

Eficiencia energética: de A++ a A

 70x21x11 cm
27,6x8,3x4,3 in
2,1kg | 4,6lb

Certificaciones:

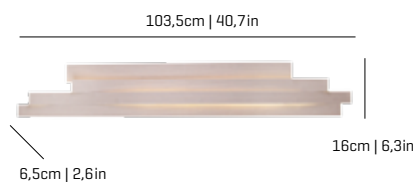

Li

by Arturo Álvarez

pg. 157 [Catálogo]

ref. LI06G

455€

TULIPA

Celulosa prensada
Un color a elegir

SOPORTE

Acero inoxidable

230V - 50Hz

LED - 1x18 W - 1446Lm - 3000K

Eficiencia energética: de A++ a A

 104x31x25 cm
40,9x12,2x9,8 in
4,7kg | 10,4lb

Certificaciones:



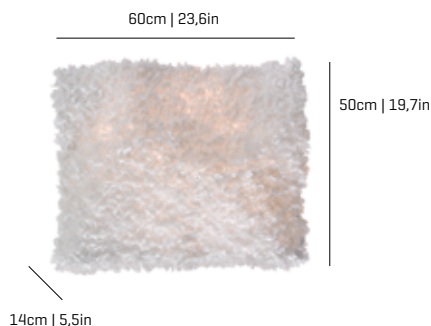

Miuu

by Arturo Álvarez

ref. **MI06: 512€** ref. **MI06-D*: 564€**

TULIPA

Tela

Uno o dos colores a elegir
o combinación de dos colores

Acero pintado galvanizado

SOPORTE

Acero inoxidable

*Regulable

230V - 50Hz

2GX13 - Max. 1x55 W

60x50x14 cm
23,6x19,7x5,5 in
3kg | 6,6lb

Eficiencia energética: de A a B



Certificaciones:

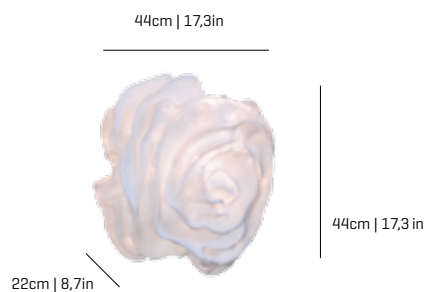

Nevo

by Arturo Álvarez

pg. 67 [Catálogo]

ref. **NE06**

339€

TULIPA

SIMETECH® by arturo alvarez
pg. 180 [Catálogo]

Un color a elegir

Acero níquel-satinado
y acero inoxidable

SOPORTE

Acero níquel-satinado
y acero inoxidable

230V - 50Hz

E14 - Max. 2x9 W
 E14 ECO - Max. 2x46 W
 E14 LED - Max. 2x7 W
 E14 - Max. 2x60 W

43x43x19 cm
16,9x16,9x7,5 in
1,9kg | 4,2lb

Eficiencia energética: de A+ a E



Certificaciones:

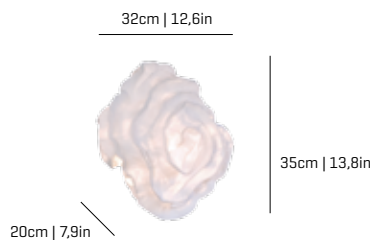

Nevo

by Arturo Álvarez

pg. 67 [Catálogo]

ref. **NE06P**

251€

TULIPA

SIMETECH® by arturo alvarez
pg. 180 [Catálogo]

Un color a elegir

Acero níquel-satinado
y acero inoxidable

SOPORTE

Acero níquel-satinado
y acero inoxidable

230V - 50Hz

G9 LED - Max. 1x3 W
 G9 ECO - Max. 1x42 W
 G9 - Max. 1x60 W

43x43x19 cm
16,9x16,9x7,5 in
1,7kg | 3,6lb

Eficiencia energética: de A+ a C



Certificaciones:

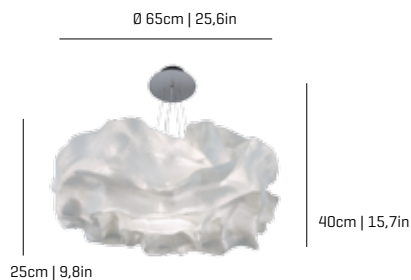

Nevo

by Arturo Álvarez

ref. **NE04 ceiling use**

565€

TULIPA

SIMETECH® by arturo alvarez
pg. 180 [Catálogo]

Un color a elegir

Acero níquel-satinado
y acero inoxidable

SOPORTE

Acero níquel-satinado
y acero inoxidable

CABLE

Transparente

230V - 50Hz

E27 - Max. 3x23 W
 E27 ECO - Max. 3x77 W
 E27 LED - Max. 3x12 W
 E27 - Max. 3x100 W

60x61x21 cm
23,6x24x8,3 in
4,3kg | 9,6lb

Eficiencia energética: de A+ a E



Certificaciones:



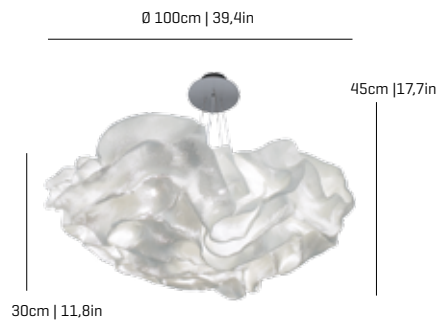

Nevo

by Arturo Álvarez

TULIPA

SIMETECH® by arturo alvarez
pg. 180 [Catálogo]

Un color a elegir

Acero níquel-satinado
y acero inoxidable

SOPORTE

Acero níquel-satinado
y acero inoxidable

CABLE

Transparente

ref. NE04G ceiling use

1130€

230V - 50Hz

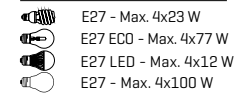

Eficiencia energética: de A+ a E

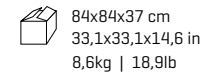

Certificaciones:

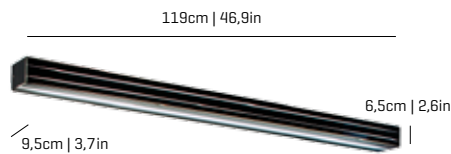

Norman

by Arturo Álvarez pg. 131 [Catálogo]

TULIPA

Vidrio
Un color a elegir*

*Excepto color 95. Beige

SOPORTE

Acero

ref. N006

693€

230V - 50Hz



Eficiencia energética: de A a B

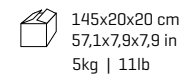

Certificaciones:

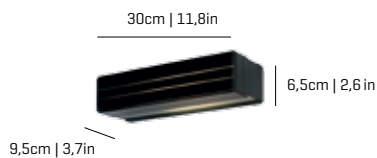

Norman

by Arturo Álvarez

TULIPA

Vidrio
Un color a elegir

SOPORTE

Acero

ref. N006P

259€

230V - 50Hz

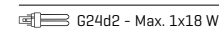

Eficiencia energética: de A a B

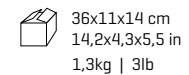

Certificaciones:



Planum

by Arturo Álvarez pg. 78 [Catálogo]

TULIPA

SIMETECH® by arturo alvarez
pg. 180 [Catálogo]

Un color a elegir

SOPORTE

Acero inoxidable

*Regulable

ref. PM06R: **689€**

ref. PM06R-D*: **783€**

230V - 50Hz

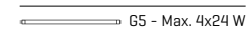

Posibilidad bombillas
de color 

Eficiencia energética: de A a B

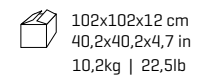

Certificaciones:





Planum

by Arturo Álvarez pg. 80 [Catálogo]

ef. PM06PR: **469€** ref. PM06PR-D*: **532€****TULIPA**SIMETECH® by arturo alvarez
pg. 180 [Catálogo]

Un color a elegir

SOPORTE

Acero inoxidable

*Regulable

230V - 50Hz

G5 - Max. 2x24 W

Posibilidad bombillas de cc

 100x53x12 cm
39,4x20,9x4,7 in
4,5kg | 9,9lb

Eficiencia energética: de A a B



Certificaciones:

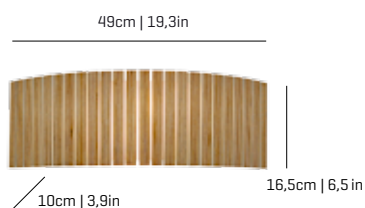

Shio

by Arturo Álvarez

ref. SH06: **370€** ref. SH06-D*: **416€****TULIPA**Tablero marino
Un color a elegir

Difusor superior e inferior

SOPORTE

Acero inoxidable

*Regulable

230V - 50Hz

G24q2 - Max. 2x18 W

Eficiencia energética: de A a B

 61x27x20 cm
24x10,6x7,9 in
2,8kg | 6,2lb

Certificaciones:

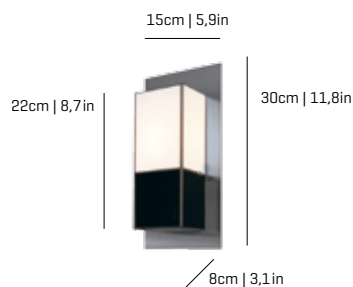

Sombras

by Arturo Álvarez

ref. S006

266€**TULIPA**Vidrio
Uno o dos colores a elegir**SOPORTE**

Acero inoxidable

230V - 50Hz

G24d1 - Max. 1x13W

Eficiencia energética: de A a B

 35x25x25 cm
13,8x9,8x9,8 in
1,9kg | 4,2lb

Certificaciones:

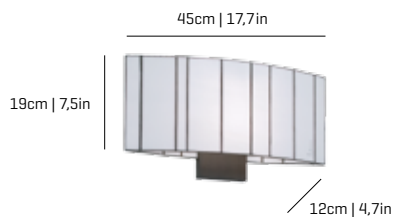

Sophi

by Arturo Álvarez

ref. SP06B

427€**TULIPA**Vidrio
Un color a elegir
o combinaciones:
Marrón
Ámbar
B&N+otro**SOPORTE**

Madera

230V - 50Hz

E14 ECO - Max. 2x46 W

E14 LED - Max. 2x7 W

E14 - Max. 2x60 W

Eficiencia energética: de A+ a E

 50x45x30 cm
19,7x17,7x11,8 in
3kg | 6,6lb

Certificaciones:



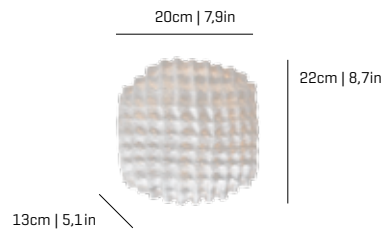

Tati

by Arturo Álvarez

pg. 54 [Catálogo]

ref. TA06

189€

TULIPA

SIMETECH® by arturo alvarez
pg. 180 [Catálogo]

Un color a elegir

SOPORTE

Acero pintado

230V - 50Hz

- ☐ G9 LED - Max. 2x3 W
- ☐ G9 ECO - Max. 2x42 W
- ☐ G9 - Max. 2x60 W

 34x24x15 cm
13,4x9,4x5,9 in
0,7kg | 1,5lb

Eficiencia energética: de A+ a C



Certificaciones:

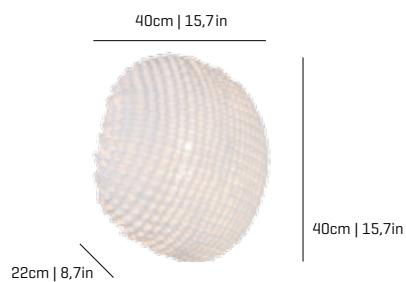

Tati

by Arturo Álvarez

pg. 55 [Catálogo]

ref. TA06G

331€

TULIPA

SIMETECH® by arturo alvarez
pg. 180 [Catálogo]

Un color a elegir

SOPORTE

Acero níquel-satinado
y acero inoxidable

230V - 50Hz

- ☐ E14 - Max. 2x9 W
- ☐ E14 ECO - Max. 2x46 W
- ☐ E14 LED - Max. 2x7 W
- ☐ E14 - Max. 2x60 W

 42x42x20 cm
16,5x16,5x7,9 in
2,4kg | 5,3lb

Eficiencia energética: de A+ a E



Certificaciones:

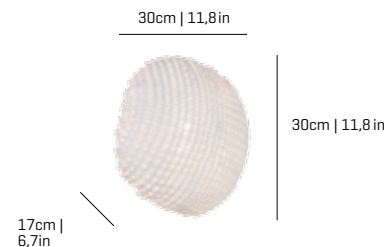

Tati

by Arturo Álvarez

pg. 55 [Catálogo]

ref. TA06P

249€

TULIPA

SIMETECH® by arturo alvarez
pg. 180 [Catálogo]

Un color a elegir

SOPORTE

Acero níquel-satinado
y acero inoxidable

230V - 50Hz

- ☐ G9 LED - Max. 1x3 W
- ☐ G9 ECO - Max. 1x42 W
- ☐ G9 - Max. 1x60 W

 42x42x20 cm
16,5x16,5x7,9 in
1kg | 2,2lb

Eficiencia energética: de A+ a C



Certificaciones:

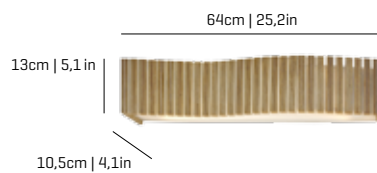

Uxi

by Arturo Álvarez

ref. UX06: **396€**ref. UX06-D*: **448€**

TULIPA

Tablero marino
Un color a elegir

Difusor superior e inferior

SOPORTE

Acero inoxidable

*Regulable

230V - 50Hz

☐ G5 - Max. 2x24 W

 80x22x25 cm
31,5x8,7x9,8 in
3,5kg | 7,7lb

Eficiencia energética: de A a B



Certificaciones:



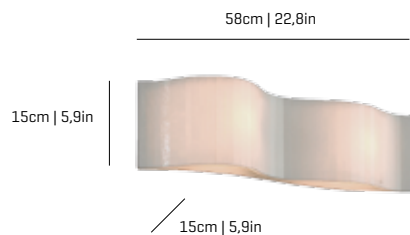

Vento

by Arturo Álvarez pg. 117 [Catálogo]

ref. VN06

508€**TULIPA**

Vidrio

Un color a elegir
o combinaciones:Rosa
Marrón
B&N**SOPORTE**

Acero inoxidable

230V - 50Hz

- ☐ G9 LED - Max. 2x3 W
- ☐ G9 ECO - Max. 2x42 W (Philips)
- ☐ G9 ECO - Max. 2x33 W (Osram)

80x30x30 cm
31,5x11,8x11,8 in
4,4kg | 9,7lb

Eficiencia energética: de A+ a C



Certificaciones:



AVISO IMPORTANTE: Las colecciones VENTO y VENTOPOP
sólo son aptas para uso con bajo consumo G9 o halógenas G9 ECO

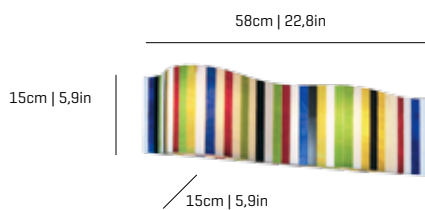

Ventopop

by Arturo Álvarez

ref. VN06POP

512€**TULIPA**

Vidrio

Colores combinación POP

SOPORTE

Acero inoxidable

230V - 50Hz

- ☐ G9 LED - Max. 2x3 W
- ☐ G9 ECO - Max. 2x42 W (Philips)
- ☐ G9 ECO - Max. 2x33 W (Osram)

80x30x30 cm
31,5x11,8x11,8 in
4,4kg | 9,7lb

Eficiencia energética: de A+ a C



Certificaciones:



AVISO IMPORTANTE: Las colecciones VENTO y VENTOPOP
sólo son aptas para uso con bajo consumo G9 o halógenas G9 ECO

ACCESORIOS

Pieza para desplazamiento de cable eléctrico

Ref. PIEZA002

Precio neto: **6€**

IVA no incluido

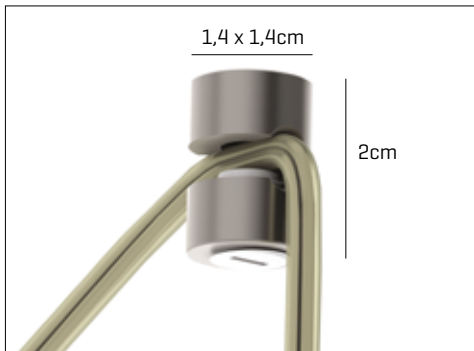

Nota: La mayoría de nuestras lámparas colgantes (individuales y composiciones) pueden colocarse utilizando piezas de desplazamiento.







Solicite presupuesto para esta opción.

Ex.









BOMBILLAS

E-14

	W	DESCRIPCIÓN	I.E.E. ¹	REF.	PRECIO ²
 E14	9	CFL/Bajo consumo MEGAMAN Round 2700K	A	ELEC0350	9€
 E14	11	CFL/Bajo consumo MEGAMAN Lilliput 2700K	A	ELEC0323	9€
 E-14 ECO	46	Tungsten halogena ECO Classic Candel 2700K	D	ELEC0348	3€
 E-14 ECO	46	Tungsten halogena ECO Classic Round 2700K	D	ELEC0349	3€
 E-14 LED	5	LED 2800K	A+	ELEC0613	20€
 E-14 LED	5	LED 2800K	A+	ELEC0614	15€

E-27

	W	DESCRIPCIÓN	I.E.E. ¹	REF.	PRECIO ²
 E27 Regulable	20	CFL PHILIPS Tornado Regulable 2700K	A	ELEC0083	21€
 E27	23	CFL PHILIPS Tornado 2700K	A	ELEC0625	8€
 E27	23	CFL MEGAMAN Globe D=98 [GSU420] 2700K	A	ELEC0506	11€
 E27 ECO	116	Tungsten halogena bulb ECO Standard 2900K	C	ELEC0617	4€
 E27 ECO	77	Tungsten halogena bulb ECO Standard 2800K	D	ELEC0081	3,5€
 E27 LED	11	LED 2800K Globo D=95	A+	ELEC0615	35€
 E27 LED	12	LED 2800K	A+	ELEC0616	33€

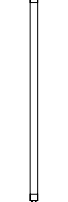

G-5

	W	DESCRIPCIÓN	I.E.E. ¹	REF.	PRECIO ²
 G5 WHITE	24	Fluorescente tubo T5 HO 3000K	A	ELEC0518	7€
G5 WHITE	54	Fluorescente tubo T5 HO 3000K	A	ELEC0519	7€
G5 WHITE	39	Fluorescente tubo T5 HO 3000K	A	ELEC0098	7€
G5 RED	24	Fluorescente tubo T5 HO		ELEC0525	14€
G5 GREEN	24	Fluorescente tubo T5 HO		ELEC0523	14€
G5 BLUE	24	Fluorescente tubo T5 HO		ELEC0522	14€

G9

	W	DESCRIPCIÓN	I.E.E. ¹	REF.	PRECIO ²
 G9 LED	3	LED bi-pin 230V G9 MEGAMAN	A+	ELEC0655	13€
 G9 ECO	42	Tungsten halogena ECOHalo PHILIPS Click Line 2800K	D	ELEC0086	7,5€
 G9 ECO	33	Tungsten halogena ECO OSRAM Halopin [66733ECO] 2700K	C	ELEC0085	5€



2GX13

	W	DESCRIPCIÓN	I.E.E. ¹	REF.	PRECIO ²
 2GX13	22	Circular Fluorescente 3000K	A	ELEC0542	21€
 2GX13	55	Circular Fluorescente 3000K	A	ELEC0544	22€

GX53

	W	DESCRIPCIÓN	I.E.E. ¹	REF.	PRECIO ²
 GX53 WHITE	9	F.C. MEGAMAN Gx019i 3000K Slim Shellite 075x24,3mm	B	ELEC0069	13€
 GX53 WHITE	13	F.C. MEGAMAN Gx0113i 3000K Slim Shellite 075x24,3mm	B	ELEC0072	14€
 GX53 LED	5	LED GX53 5W 2800K 075x25mm	A+	ELEC0656	34€
 GX53 RED	9	F.C. MEGAMAN Gx0109i 3000K Slim Shellite 075x24,3mm		ELEC0073	14€
 GX53 GREEN	9	F.C. MEGAMAN Gx0109i 3000K Slim Shellite 075x24,3mm		ELEC0074	14€
 GX53 BLUE	9	F.C. MEGAMAN Gx0109i 3000K Slim Shellite 075x24,3mm		ELEC0075	14€

G24d1 / G24d2 / G24d3 / G24q2

	W	DESCRIPCIÓN	I.E.E. ¹	REF.	PRECIO ²
 G24d1	13	Fluorescente compacta D1-13W 2700K	B	ELEC0503	4,5€
 G24d2	18	Fluorescente compacta D2-18W 2700K	B	ELEC0452	4,5€
 G24d3	26	Fluorescente compacta D3-26W 2700K	B	ELEC0504	4,5€
 G24q2	18	Fluorescente compacta Q2-18W 2700K	B	ELEC0468	4,5€

¹I.E.E.: Índice de Eficiencia Energética. Este índice es sólo una estimación y puede cambiar de un fabricante a otro.

²PRECIO NETO. IVA no incluido.

Nota: Las marcas que se suministran son Osram, Philips o Megaman. En caso de no disponer de las marcas indicadas, se suministrarán otras de calidad equivalente.

CONDICIONES DE VENTA (LEER ATENTAMENTE)

Todas las ventas se realizarán de acuerdo a las siguientes condiciones, las cuales serán aceptadas por el cliente desde el momento de cursar el pedido. Esta tarifa sustituye a todas las anteriores.

1- PORTES

Portes pagados a cualquier punto de la península. Andorra y Baleares portes pagados para pedidos superiores a 1.200€ PVP sin IVA y si son inferiores a ese importe o van hacia Canarias se cargarán en factura o se aplicarán condiciones EXW, INCOTERMS® 2010, ICC PARIS.

2-PLAZO DE ENTREGA

No se aceptarán pedidos telefónicos. Deberán confirmarse mediante un medio escrito por fax: +34 981 50 20 00 o bien al e-mail: pedidos@arturo-alvarez.com. Una vez emita un pedido a fábrica **recibirá una CONFIRMACIÓN DE PEDIDO, cualquier rectificación de pedido deberá hacerla antes de pasadas 48 horas desde que reciba esta confirmación. Si pasadas las 48 hrs. no recibimos ninguna rectificación, ESE PEDIDO SE DARÁ COMO VÁLIDO EN TODOS SUS TÉRMINOS.** Esto significa que **desde ese momento entra en producción y no se puede modificar ni anular.** Una vez en producción el plazo de entrega máximo será de 4 semanas. Los plazos de entrega son sin compromiso, no se admitirán reclamaciones por demora de entrega ni otro tipo de demandas o indemnizaciones.

3-PRECIOS Y FORMA DE PAGO

Las cantidades reflejadas en **nuestra lista de precios son PVP recomendado sin IVA.** Las condiciones de pago serán acordadas individualmente con cada cliente.

En el caso de pago aplazado el cómputo de éste se iniciará a partir de la fecha de la factura, siendo respetados los días fijos de pago si los hubiera.

Los pedidos iniciales o de clientes que no hayan realizado una compra en los últimos 12 meses se realizarán mediante transferencia previa. Todos los gastos que esto suponga correrán a cargo del cliente.

La mercancía suministrada es propiedad de Calor Color S.L. hasta el momento en que se haga efectivo la totalidad de su pago.

En caso de impago de algún recibo a su vencimiento **serán repercutidos al cliente todos los gastos bancarios originados.**

El comprador no está autorizado a retener la totalidad o parte de los pagos vencidos por no habersele reconocido alguna reclamación, ya que ésta no le exime de su compromiso de pago.

4-ROTURAS DE TRANSPORTES E INCIDENCIAS

En el momento de la recepción de la mercancía el cliente tiene la **obligación de revisar el estado de los bultos y anotar en el albarán** que le entregue el transportista si observa señales exteriores de aplastamientos o roturas de cajas, así como también si el transportista ha tratado los bultos incorrectamente.

Las **reclamaciones** por defecto en la cantidad o calidad deberán comunicarse en un **plazo máximo de 24 horas**, desde el momento de la recepción de la mercancía.

En caso de **rotura por transporte** hay un plazo **máximo de 24 hrs.**, desde la recepción de la mercancía, **para avisar a fábrica** al departamento de atención al cliente; **pasado este plazo, el cliente se responsabilizará de los gastos originados en portes y restauración.**

En caso de haber alguna reclamación deberá informar a fábrica, donde le darán un nº de incidencia, que deberá anotar en un lugar visible del bulto que se envíe a fábrica. Este requisito permitirá identificar el material cuando llegue a nuestras instalaciones.

Cada reclamación llevará un **nº de incidencia** diferente. Sin este requisito no se admitirá material alguno. **Los bultos que lleguen sin aviso, ni nº de incidencia serán devueltos al remitente.** Si la incidencia de la que se nos ha informado no coincide con la recibida o si la pieza tampoco coincide con la comunicada, el cliente asumirá los costes adicionales originados.

Calor Color S.L. asumirá los costes de reparación del material que se haya roto en transporte siempre que se haya avisado en el plazo máximo establecido desde la recepción de la mercancía.

Calor Color S.L. se hará cargo del coste de reparación y portes del material que tuviera un defecto de fabricación, previa inspección y confirmación del departamento de calidad, una vez recibido el material en fábrica.

En todos los otros casos el cliente asumirá los costes de reparación y transporte, incluido aquel material que haya sido enviado asegurado y no se haya **revisado en 24 hrs.**

En ningún caso nos haremos cargo del coste de la restauración o portes de material instalado en tienda, en casa de particulares o en instalaciones comerciales.

Piezas de vidrio opalescente; este vidrio puede presentar en ocasiones: líneas, puntos, zonas de diferente tonalidad o irregularidades en su superficie. Todas estas son características de este tipo de vidrio y no se pueden considerar como defectos.

Las bombillas suministradas son sometidas a un control de calidad, el que realiza su fabricante.

Calor Color S.L. se reserva el derecho de no aceptar incidencias sobre bombillas.

5-ANULACIÓN DE PEDIDOS

El plazo máximo para **anular pedidos será de 48 hrs.** después de recibir la confirmación de pedido. Pasado este plazo no se admitirán anulaciones o modificaciones de pedido.

6-DEVOLUCIONES

Como norma general **no se admitirá devolución alguna.** En casos excepcionales, para autorizar la devolución deberá solicitar un nº de incidencia en el departamento de atención al cliente. El cual es requisito indispensable para la recepción y comprobación de estado en fábrica.

En material devuelto se abonará un máximo de un 90 % del valor de la factura, corriendo a cargo del cliente los costes de reparación cuando el material no se reciba en perfecto estado y con su embalaje original. Los portes siempre correrán a cargo del cliente.

No se admitirá la devolución de ninguna luminaria de fabricación especial o con sus colores originales cambiados o descatalogada, ni material que haya sido instalado. No se admitirá ninguna devolución transcurridos tres meses desde su entrega.

7-MODIFICACIONES DE PRODUCTO

Para las pantallas que son de un solo color, podrá elegirse el que se desee, en ningún caso podrán mezclarse varios colores.

En las pantallas bicolor en ningún caso se admitirá la combinación de más de dos colores.

No se fabricarán lámparas que tengan varias tulipas, en un color de pantalla diferente para cada una de ellas.

Para todo tipo de colgante que se pida con mayor altura de la medida estandarizada de catálogo se servirá siempre al doble de metros indicados en tarifa y tendrá un incremento del: **3% hasta 599€ de PVP y 2% a partir de 600€ de PVP.** Para alturas mayores de 3 m., consultar precio.

8-GARANTÍA

El material electrónico tiene garantía por dos años.

Calor Color S.L. se reserva el derecho de hacer todos los cambios que estime oportunos, sin previo aviso, y con el fin de mejorar las luminarias.

En caso de litigio se renuncia a su propio fuero, se somete a la competencia exclusiva de los juzgados y tribunales de la provincia de A Coruña.

Las presentes condiciones de venta sustituyen a todas las anteriores.